

## MICRO PORT TYPE P NW 25

ART. NO. 900014

### GENERAL



The KEOFITT MICRO PORT is a re-sealing rubber septum designed to take samples using hypodermic needles or syringes with minimal risk of cross-contamination. Designed for sampling low viscosity products.



The sampling valve can be used for any process sampling for chemical and/or physical analysis.



To be used with cotton wick for sanitation (900055)



The product to be sampled should have a maximum viscosity of 0-50 cP.



Please note that the sealing capacity is reduced with piercing.



### FEATURES



Installation: Pipe welding



Operation: Manually operated



To be used with hypodermic needle (900054)



Septum: Butyl IIR (B402F - grey)

### CERTIFICATION\*

· Conforms to 3-A · EHEDG CIP · 3.1 Material Certificate · EU 1935/2004

### TECHNICAL DATA

#### Material (product contact)

· Steel parts	AISI 316L (1.4404)
· Membrane	Butyl IIR (B402F - grey)

#### Material (without product contact)

· Steel parts	AISI 316L (1.4404)
· O-ring	EPDM (FDA · EU 1935/2004)

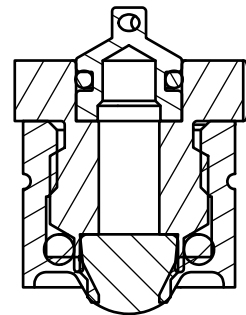

#### Septum

· Article & Certification\* BUTYL IIR, GREY (#900049) FDA · USP · EU 1935/2004

#### Surface Treatment

· Outside	Electropolished Ra <= 1.2 µm
· Inside & process	Ra <= 0.5 µm

#### Pressure & Temperature

· Pressure	0 - 6 bar (g) / 0 - 87 psi (g)
· Temperature	1 - 110°C / 34 - 230° F

#### Net Weight







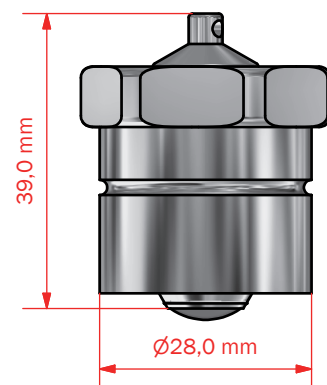
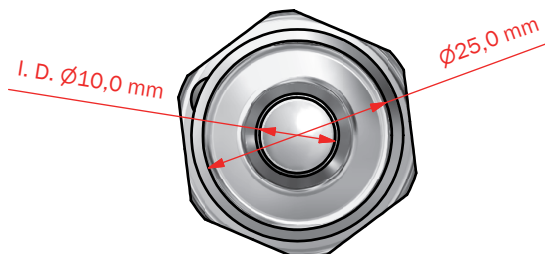























· Kg/lbs N/A / 0,32 lbs

#### Spareparts

779056 PARTS FOR MICRO PORT 900014/56/57



**MICRO PORT / MULTI MICRO PORT 49**

		Multi Micro Port 49		
		Tank Welding	Varivent Ø68	Clamp 3"
		7xEPDM membrane	7xEPDM membrane	7xEPDM membrane
Silicone membrane	Tank	Not available	Not available	Not available
	Pipe Welding 1"	Not available	Not available	Not available
	Pipe Welding NW25	Not available	Not available	Not available
Butyl (IRR) membrane	Tank	 900056	 900057	 900014
	Pipe Welding 1"	 900056	 900057	 900014
	Pipe Welding NW25	 900056	 900057	 900014
PTFE membrane	Tank	 900056	 900057	 900014
	Pipe Welding 1"	 900056	 900057	 900014
	Pipe Welding NW25	 900056	 900057	 900014
		 900056	 900057	 900014
		 900056	 900057	 900014
		 900056	 900057	 900014
		 900056	 900057	 900014