





REFLEX VALVE TYPE P 1½" W/TC

ART. NO. 880010

GENERAL

-  The KEOFITT REFLEX Sampling Valve is KEOFITT's newest and patented double-seat sampling valve. Unique in the market, it eliminates SIP dead-leg during sampling while also incorporating steam supply control.
-  The sampling valve can be used for any process sampling for chemical and/or physical analysis.
-  The valve can be cleaned by means of CIP (EHEDG certified). Not recommended for autoclave due to plastic parts.
-  The product to be sampled should have a maximum viscosity of 0-1.000 cP and should not contain particles larger than 2 mm diameter.
-  The threaded steam supply connection (inlet) comes mounted with a hose piece. Alternative mini clamp and welding liner connections are included.

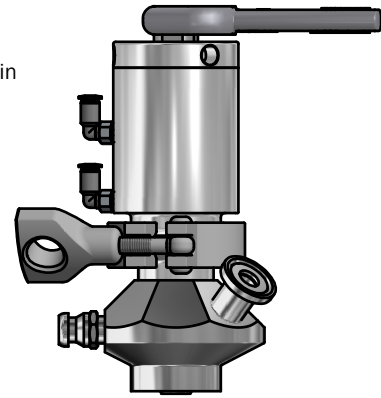

FEATURES

-  Installation: Pipe welding
-  Operation: Pneumatically operated/lever handle
-  Outlet: Mini Tri-Clamp
-  Membrane: Silicone (QBF-65 - grey)

CERTIFICATION*

· Conforms to 3-A · EHEDG CIP · 3.1 Material Certificate · EU 1935/2004 · RA certificate

TECHNICAL DATA

Material (product contact)

- Steel parts AISI 316L (1.4404)
- Membrane Silicone (QBF-65 - grey)

Material (without product contact)

- Steel parts AISI 316L (1.4404)
- Steel parts AISI 303L (1.4305)
- Lever handle AISI 316 (1.4404)
- O-ring Silicone (FDA · EU 1935/2004)

Membrane

- Article & Certification* SILICONE, GREY (# 880051) FDA · USP · EU 1935/2004

Surface Treatment

- Outside Electropolished Ra <= 1.2 µm
- Inside & process Ra <= 0.5 µm

Pressure & Temperature

- Pressure 0 - 6 bar (g) / 0 - 87 psi (g)
- Temperature 1 - 130 °C / 34 - 266 ° F
- Air supply 4 - 7 bar (g) / 58 - 101 psi (g)









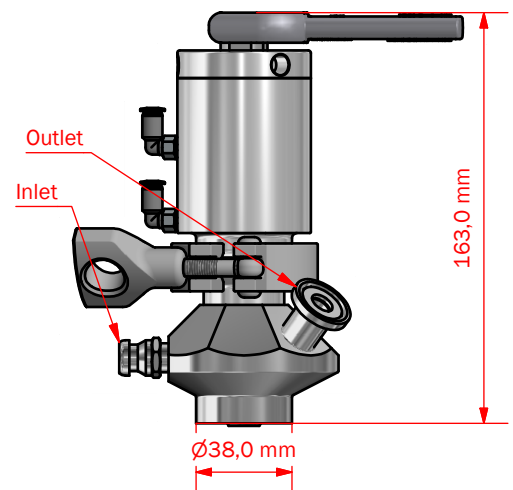
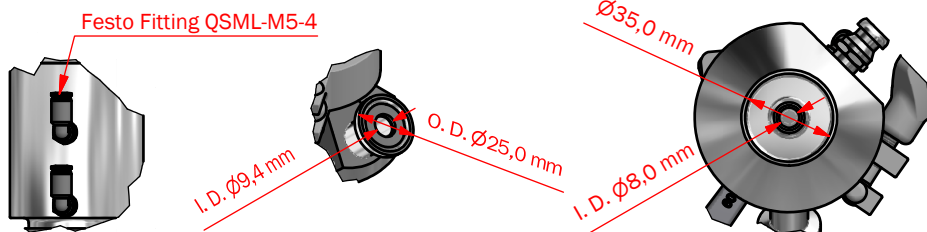
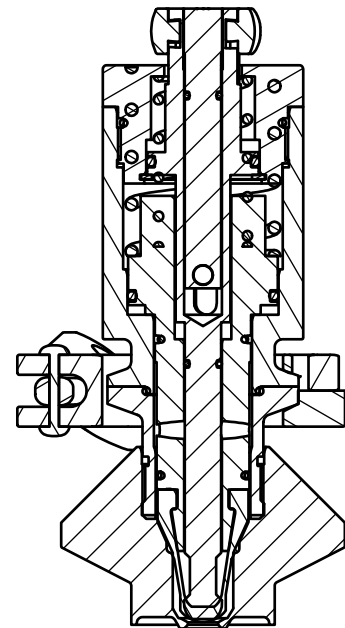







Net Weight

- Kg/lbs 2,458 kg / 5,42 lbs

Spareparts

- 778801 PARTS FOR REFLEX



| | Welding valves | | Ingold® | Connection valves | | | |
|----------------|---|---|---|--|---|---|---|
| | Tank Welding | Pipe Welding | | Varivent Ø50 | Varivent Ø68 | Clamp 1" | Clamp 2" |
| Hose Piece |  |  | |  |  |  |  |
| | 880001 | 880011 | | 880008 | 880009 | 880021 | 880003 |
| | 880001E | 880011E | | 880008E | 880009E | 880021E | 880003E |
| PTFE | 885501 | 885511 | | 885508 | 885509 | 885521 | 885503 |
| Mini Tri-Clamp |  |  |  | | |  |  |
| | 880006 | 880010 | | | | 880022 | 880005 |
| | 880006E | 880010E | | | | 880022E | 880005E |
| PTFE | 885506 | 885510 | 885532 | | | 885522 | 885505 |
| Welding liner |  |  |  | | |  |  |
| | 880007 | 880017 | | | | 880027 | On request |
| | 880007E | 880017E | | | | 880027E | On request |
| PTFE | 885507 | 885517 | 885537 | | | 885527 | On request |