





REFLEX VALVE TYPE T W/TC EPDM

ART. NO. 880006E

GENERAL

-  The KEOFITT REFLEX Sampling Valve is KEOFITT's newest and patented double-seat sampling valve. Unique in the market, it eliminates SIP dead-leg during sampling while also incorporating steam supply control.
-  The sampling valve can be used for any process sampling for chemical and/or physical analysis.
-  The valve can be cleaned by means of CIP (EHEDG certified). Not recommended for autoclave due to plastic parts.
-  The product to be sampled should have a maximum viscosity of 0-1.000 cP and should not contain particles larger than 2 mm diameter.
-  The threaded steam supply connection (inlet) comes mounted with a hose piece. Alternative mini clamp and welding liner connections are included.

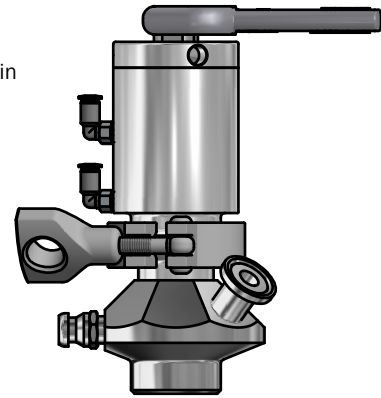

FEATURES

-  Installation: Tank welding
-  Operation: Pneumatically operated/lever handle
-  Outlet: Mini Tri-Clamp
-  Membrane: EPDM (EPL-60 - black)

CERTIFICATION*

· Conforms to 3-A · EHEDG CIP · 3.1 Material Certificate · EU 1935/2004 · RA certificate

TECHNICAL DATA

Material (product contact)

- Steel parts AISI 316L (1.4404)
- Membrane EPDM (EPL-60 - black)

Material (without product contact)

- Steel parts AISI 316L (1.4404)
- Steel parts AISI 303L (1.4305)
- Lever handle AISI 316 (1.4404)
- O-ring Silicone (FDA · EU 1935/2004)

Membrane

- Article & Certification* EPDM, BLACK (# 880052) FDA · USP · EU 1935/2004

Surface Treatment

- Outside Electropolished Ra <= 1.2 µm
- Inside & process Ra <= 0.5 µm

Pressure & Temperature

- Pressure 0 - 6 bar (g) / 0 - 87 psi (g)
- Temperature 1 - 130 °C / 34 - 266 ° F
- Air supply 4 - 7 bar (g) / 58 - 101 psi (g)









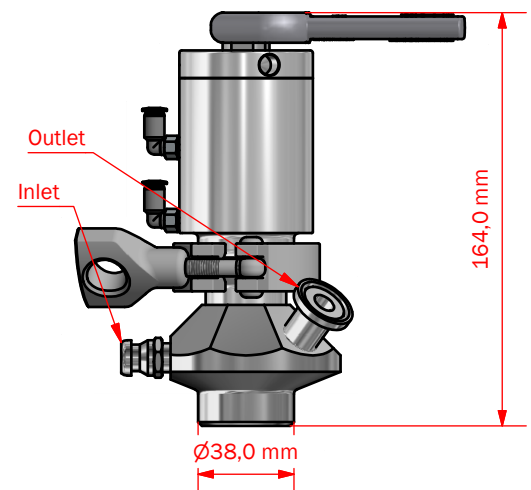
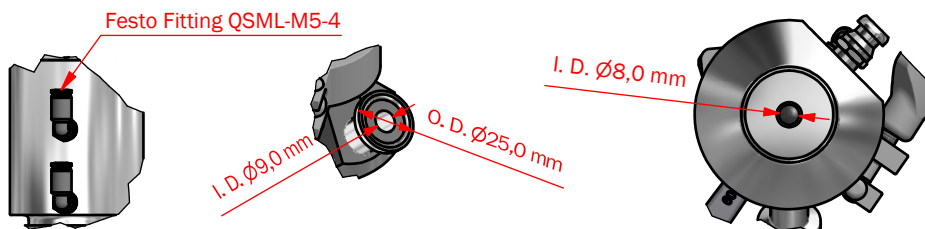
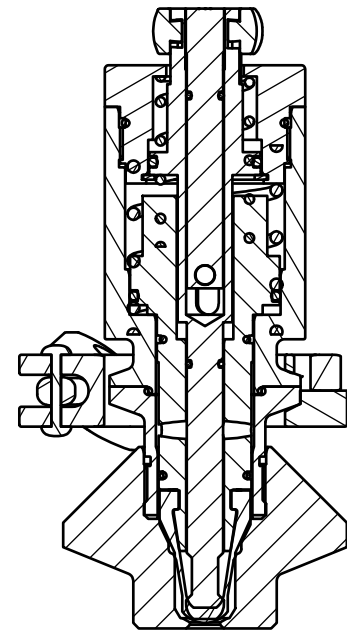







Net Weight

- Kg/lbs 2,454 kg / 5,41 lbs

Spareparts

- 778801EPDM PARTS FOR REFLEX



	Welding valves		Ingold®	Connection valves			
	Tank Welding	Pipe Welding		Varivent Ø50	Varivent Ø68	Clamp 1"	Clamp 2"
Hose Piece							
	880001	880011		880008	880009	880021	880003
	880001E	880011E		880008E	880009E	880021E	880003E
PTFE	885501	885511		885508	885509	885521	885503
Mini Tri-Clamp							
	880006	880010			880022		880005
	880006E	880010E			880022E		880005E
PTFE	885506	885510	885532		885522		885505
Welding liner							
	880007	880017				880027	On request
	880007E	880017E				880027E	On request
PTFE	885507	885517	885537			885527	On request