





# REFLEX VALVE TYPE C2"/N

ART. NO. 880003

## GENERAL

-  The KEOFITT REFLEX Sampling Valve is KEOFITT's newest and patented double-seat sampling valve. Unique in the market, it eliminates SIP dead-leg during sampling while also incorporating steam supply control.
-  The sampling valve can be used for any process sampling for chemical and/or physical analysis.
-  The valve can be sterilized by means of SIP (EHEDG test) and cleaned by means of CIP (EHEDG certified). Not recommended for autoclave due to plastic parts.
-  The product to be sampled should have a maximum viscosity of 0-1.000 cP and should not contain particles larger than 2 mm diameter.
-  The threaded steam supply connection (inlet) comes mounted with a hose piece. Alternative mini clamp and welding liner connections are included.

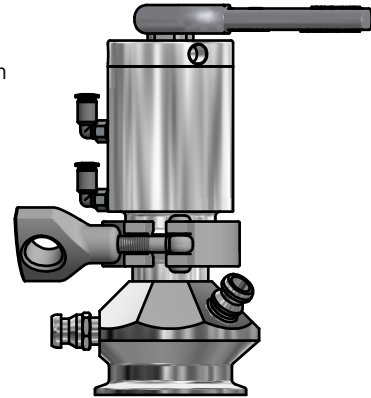

## FEATURES

-  Installation: Clamp connection 2"
-  Operation: Pneumatically operated/lever handle
-  Outlet: Hose piece
-  Membrane: Silicone (QBF-65 - grey)

## CERTIFICATION\*

· Conforms to 3-A · EHEDG CIP · 3.1 Material Certificate · EU 1935/2004 · RA certificate

## TECHNICAL DATA

### Material (product contact)

- Steel parts                   AISI 316L (1.4404)
- Membrane                   Silicone (QBF-65 - grey)

### Material (without product contact)

- Steel parts                   AISI 316L (1.4404)
- Steel parts                   AISI 303L (1.4305)
- Lever handle                AISI 316 (1.4404)
- O-ring                        Silicone (FDA · EU 1935/2004)

### Membrane

- Article & Certification\*    SILICONE, GREY (# 880051) FDA · USP · EU 1935/2004

### Surface Treatment

- Outside                      Electropolished Ra <= 1.2 µm
- Inside & process           Ra <= 0.5 µm

### Pressure & Temperature

- Pressure                     0 - 6 bar (g) / 0 - 87 psi (g)
- Temperature                1 - 130 °C / 34 - 266 ° F
- Air supply                   4 - 7 bar (g) / 58 - 101 psi (g)









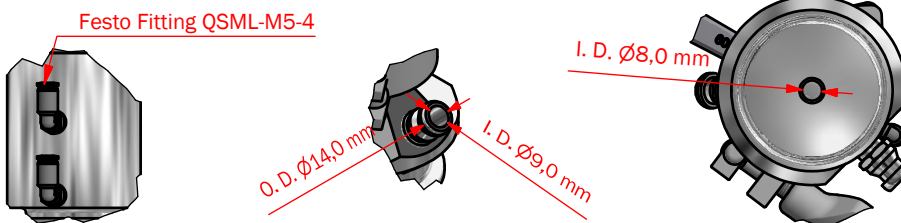
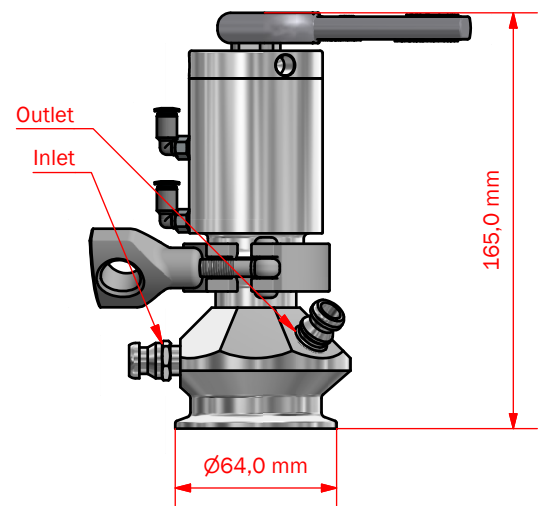
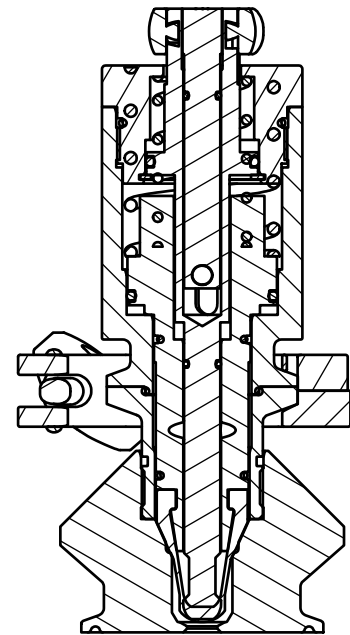







### Net Weight

- Kg/lbs                        2,610 kg / 5,75 lbs

### Spareparts

- 778801                        PARTS FOR REFLEX



	Welding valves		Ingold®	Connection valves			
	Tank Welding	Pipe Welding		Varivent Ø50	Varivent Ø68	Clamp 1"	Clamp 2"
Hose Piece							
	880001	880011		880008	880009	880021	880003
	880001E	880011E		880008E	880009E	880021E	880003E
PTFE	885501	885511		885508	885509	885521	885503
Mini Tri-Clamp							
	880006	880010				880022	880005
	880006E	880010E				880022E	880005E
PTFE	885506	885510	885532			885522	885505
Welding liner							
	880007	880017				880027	On request
	880007E	880017E				880027E	On request
PTFE	885507	885517	885537			885527	On request