





## VALVE HEAD W9 TYPE N/Adjustable

ART. NO. 855545

### GENERAL

-  The KEOFITT CLASSIC W9 Sampling Valve is the original and leading sterilizable sampling valve in the world. Used in all industries for decades. + 320 standard valve configurations. Unique serial no. for each valve ("E" = internal electro polish).
-  The sampling valve can be used for any process sampling for microbiological, chemical and/or physical analysis.
-  Cleaning/sterilizing: Between batches: Valve in open position: Cleanable by means of CIP using the detergent solution suitable for the actual process media (EHEDG certificate available). Between samples: Valve in its normal closed position: cleanable by CIP as "Between batches" or the valve may be sterilized by means of steam SIP (EHEDG test report available) or chemical SIP using a procedure appropriate to the actual circumstances. For further advice, please contact Keofitt.
-  Designed for sampling of liquids with a viscosity of up to approx. 1.000 cP containing no particles larger than Ø3 mm. Sampling of more viscous liquids is possible, only will it take longer (depending on process pressure).

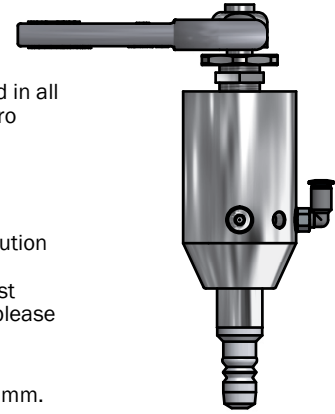

### FEATURES

-  Installation: Threaded connection
-  Operation: Pneumatically operated/lever handle
-  Depending on choice of valve body
-  Membrane: PTFE (TFM 1600 - white)

### CERTIFICATION\*

· Conforms to 3-A · EHEDG CIP 530

### TECHNICAL DATA

#### Material (product contact)

· Membrane PTFE (TFM 1600 - white)

#### Material (without product contact)

· Steel parts AISI 303L (1.4305)  
· Steel parts AISI 316L (1.4404)

#### Membrane

· Article PTFE, WHITE (# 850055)  
· Certification\* FDA · USP · EU 1935/2004

#### Pressure & Temperature

· Pressure 0 - 6 bar (g) / 0 - 87 psi (g)  
· Temperature 1 - 150° C / 34 - 302° F  
· Air supply 4 - 7 bar (g) / 58 - 101 psi (g)

#### Net Weight

· Kg/lbs 0,963 kg / 2,02 lbs





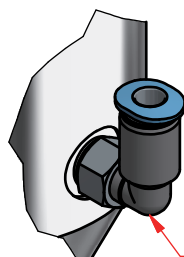
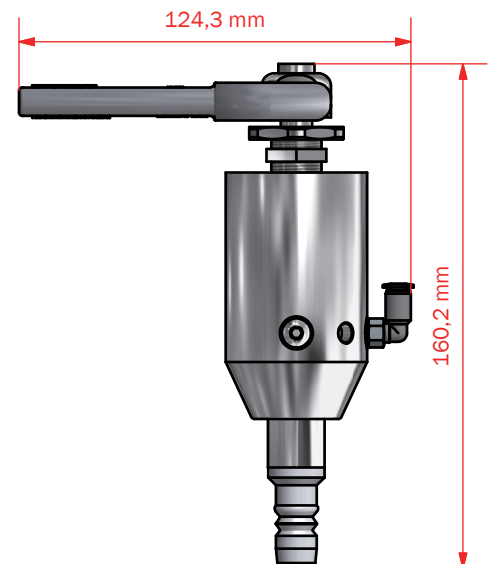
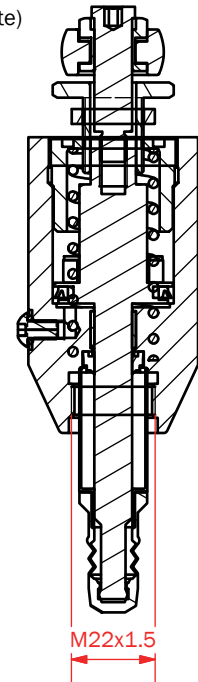















#### Spareparts

778544 PARTS FOR W9 HEAD 855544



Festo Fitting QSML-M5-4

**W 9 HEADS**

		<b>Connection bodies</b>						<b>Welding bodies</b>			
		Thread	Clamp 2"	Clamp 1"	Mini Clamp	Varivent Ø68	Varivent Ø50	Pipe Welding	Pipe Welding	Tank Welding	
											<b>Hoses Piece</b>
		850031	850003	850021	850036	850009	850008	850014	850011	850001	
		<i>On request</i>		 850022  850025			<i>On request</i>	<i>On request</i>			<b>Mini Clamp</b>
		<i>On request</i>	850005		850039	850013	<i>On request</i>	<i>On request</i>			
		<i>On request</i>	<i>On request</i>								<b>Thread M16x1,5</b>
				850024				850018	850016	850015	