





VALVE HEAD W9 TYPE Q PTFE

ART. NO. 855543

GENERAL

-  The KEOFITT CLASSIC W9 Sampling Valve is the original and leading sterilizable sampling valve in the world. Used in all industries for decades. + 320 standard valve configurations. Unique serial no. for each valve ("E" = internal electro polish).
-  The sampling valve can be used for any process sampling for microbiological, chemical and/or physical analysis.
-  The valve can be sterilized by means of SIP (EHEDG test) and cleaned by means of CIP (EHEDG certified). Suited for autoclave.
-  Designed for sampling of liquids with a viscosity of up to approx. 1.000 cP containing no particles larger than Ø3 mm. Sampling of more viscous liquids is possible, only will it take longer (depending on process pressure).

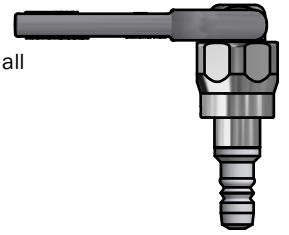

FEATURES

-  Installation: Threaded connection
-  Operation: Lever handle
-  Depending on choice of valve body
-  Membrane: PTFE (TFM 1600 - white)

CERTIFICATION*

- Conforms to 3-A · EHEDG CIP · EU 1935/2004

TECHNICAL DATA

Material (product contact)

- Membrane PTFE (TFM 1600 - white)

Material (without product contact)

- Steel parts AISI 303L (1.4305)
- Steel parts AISI 316L (1.4404)

Membrane

- Article PTFE, WHITE (# 850055)
- Certification* FDA · USP · EU 1935/2004

Pressure & Temperature

- Pressure 0 - 6 bar (g) / 0 - 87 psi (g)
- Temperature 1 - 150 °C / 34 - 302 ° F
- Air supply -

Net Weight







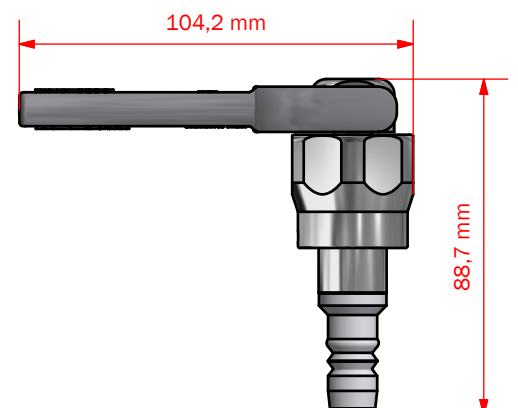
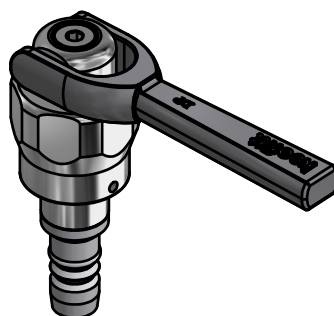
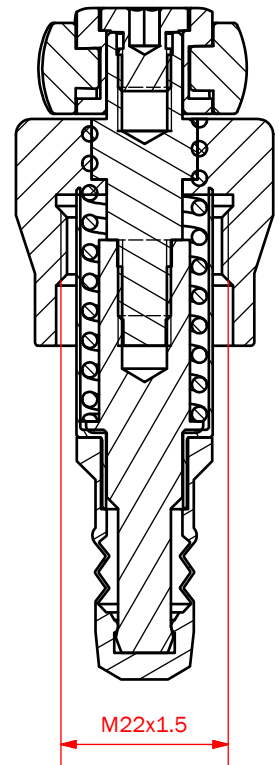

























- Kg/lbs 0,311 kg / 0,68 lbs

Spareparts

- 778541 PARTS FOR W9 HEAD 855541/42/43/47



KEOFITT CLASSIC W9 SAMPLING VALVE - BODIES

W9 BODIES		WELDING BODIES						CONNECTION BODIES						
		Tank Welding 928	Pipe Welding 1"	Pipe Welding NW25	In-Line Vertical	In-Line Horizontal	Varivent 050	Varivent 068	Clamp 1/2"	Clamp 1"	Clamp 2"	Thread		
Hose Piece	 850001	 8500011	 8500014	 8500027*	 8500028*	 8500008	 8500009	 8500036	 8500021	 8500003	 8500031			
Mini Tri-Clamp	 8500006	 8500010				 On request	 8500013	 8500039	 8500022 8500025	 8500005		 On request		
Thread M16x1,5	 8500015	 8500016	 8500018			 On request	 On request	 On request	 8500024			 On request		
Welding Ends	 8500007	 8500019				 On request	 On request	 On request				 On request		

* ON REQUEST ONLY