



VALVE BODY W9 DIN 15 ACC. TO DIN 11851

ART. NO. 850040.2

GENERAL

 The KEOFITT CLASSIC W9 Sampling Valve is the original and leading sterilizable sampling valve in the world. Used in all industries for decades. + 320 standard valve configurations. Unique serial no. for each valve ("E" = internal electro polish).

 Designed for sampling of liquids with a viscosity of up to approx. 1.000 cP containing no particles larger than Ø3 mm. Sampling of more viscous liquids is possible, only will it take longer (depending on process pressure).

 Cleaning/sterilizing: Between batches: Valve in open position: Cleanable by means of CIP using the detergent solution suitable for the actual process media (EHEDG certificate available). Between samples: Valve in its normal closed position: cleanable by CIP as "Between batches" or the valve may be sterilized by means of steam SIP (EHEDG test report available) or chemical SIP using a procedure appropriate to the actual circumstances. For further advice, please contact Keofitt.

 The sampling valve can be used for any process sampling for microbiological, chemical and/or physical analysis.

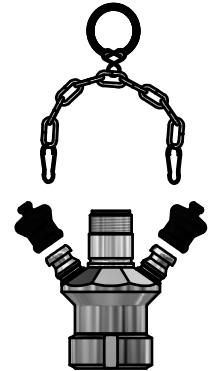

FEATURES

 Installation: Threaded socket connection DIN 15 acc. to DIN 11851

 Operation: Depending on choice of valve head

 Inlet / Outlet: Hose piece

 Membrane: Depending on choice of valve head

CERTIFICATION*

· EHEDG CIP · Conforms to 3-A · 3.1 Material Certificate · EU 1935/2004 · Ra Cert. incl. measurements

TECHNICAL DATA

Material (product contact)

· Steel parts AISI 316L (1.4404)

Material (without product contact)

· Steel parts AISI 316L (1.4404)
· Rubber cap EPDM (black)
· Stainless steel chain Stainless steel

Surface Treatment

· Outside Electropolished Ra ≤ 1.2 µm
· Inside (wetted surface) Electropolished Ra ≤ 0.5 µm
· Process connection Electropolished Ra ≤ 0.5 µm

Pressure & Temperature

· Pressure Depending on choice of valve head
· Temperature Depending on choice of valve head
· Air supply Depending on choice of valve head

Net Weight







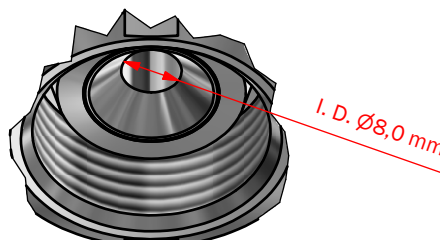
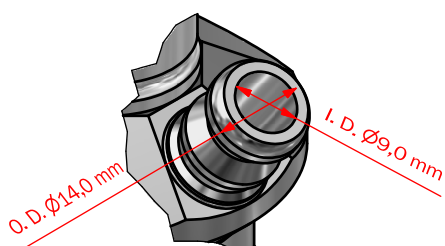
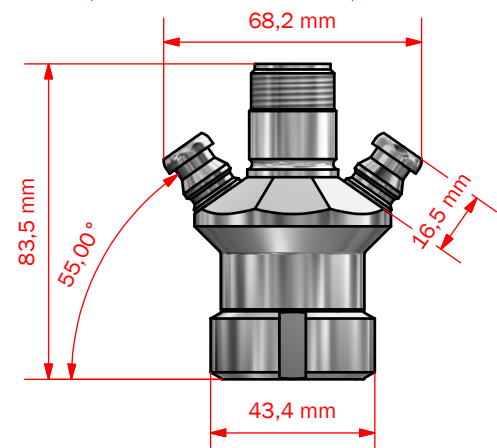
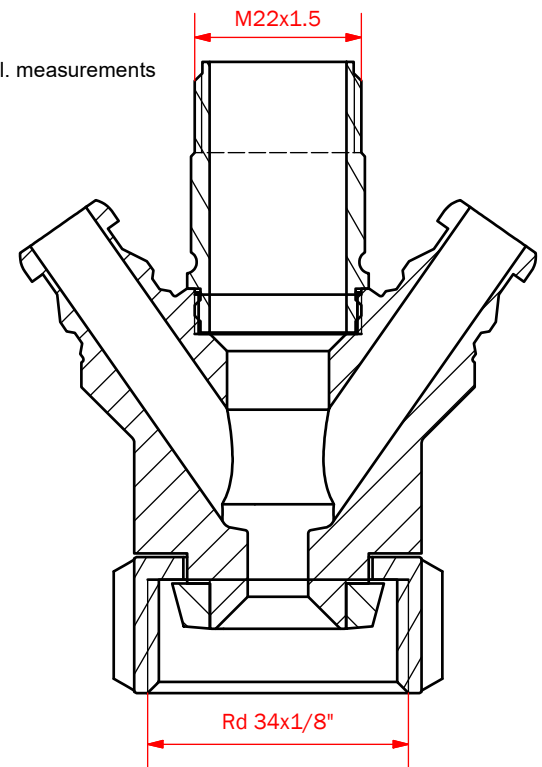



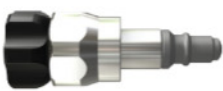



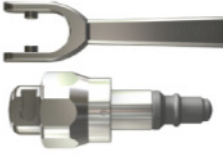

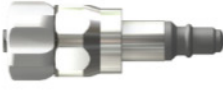

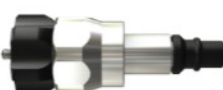

· Kg/lbs 0.511 kg /1,127 lbs

Spareparts

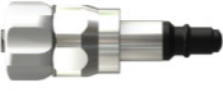
778501 PARTS FOR W9 850001/03/11/14/21/27/28/36

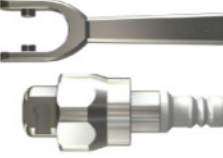

W 9 HEADS

	Type H Turn knob	Type H Turn knob with Microport option	Type K Key ring	Type K Key ring with Microport option	Key Ring for valve head	Type Q Lever handle	Type N Lever handle Pneumatic	Type B No spring 0-1.2 bar(g)
Silicone	 600041	 600048	 600042	 600049	 600076	 600043	 600044	 600047
EPDM	 600041E	 600048E	 600042E	 600049E	 600076	 600043E	 600044E	 600047E
PTFE	 855541	<i>Not available</i>	 855542	<i>Not available</i>	 600076	 855543	 855544	 855547