





## W9 IN-LINE VERTICAL ON REQUEST ONLY!

ART. NO. 850027

### GENERAL

-  The KEOFIT CLASSIC W9 Sampling Valve is the original and leading sterilizable sampling valve in the world. Used in all industries for decades. + 320 standard valve configurations. Unique serial no. for each valve ("E" = internal electro polish).
-  Valve body designed for sampling of liquids with a viscosity of up to approx. 1.000 cP containing no particles larger than Ø3 mm. Sampling of more viscous liquids is possible, only will it take longer (depending on process pressure).
-  Cleaning/sterilizing: Between batches: Valve in open position: Cleanable by means of CIP using the detergent solution suitable for the actual process media (EHEDG certificate available). Between samples: Valve in its normal closed position: cleanable by CIP as "Between batches" or the valve may be sterilized by means of steam SIP (EHEDG test report available) or chemical SIP using a procedure appropriate to the actual circumstances. For further advice, please contact Keofitt.
-  Valve body designed for sampling of liquids with a viscosity of up to approx. 1.000 cP containing no particles larger than Ø3 mm. Sampling of more viscous liquids is possible, only will it take longer (depending on process pressure).

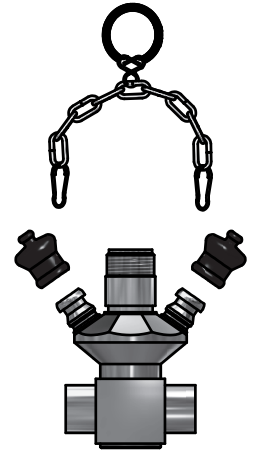

### FEATURES

-  Installation: In-line pipe welding - vertical
-  Operation: Depending on choice of valve head
-  Inlet / Outlet: Hose piece
-  Membrane: Depending on choice of valve head

### CERTIFICATION\*

· Conforms to 3-A · EHEDG CIP · 3.1 Material Certificate · EU 1935/2004 · Ra Cert. incl. measurements

### TECHNICAL DATA

#### Material (product contact)

· Steel parts                      AISI 316L (1.4404)

#### Material (without product contact)

· Steel parts                      AISI 316L (1.4404)  
 · Rubber cap                    EPDM (black)  
 · Stainless steel chain        Stainless steel

#### Surface Treatment

· Outside                            Electropolished Ra <= 1.2 µm  
 · Inside (wetted surface)      Ra <= 0.5 µm  
 · Process connection        Electropolished Ra <= 0.5 µm

#### Pressure & Temperature

· Pressure                            Depending on choice of valve head  
 · Temperature                    Depending on choice of valve head  
 · Air supply                        Depending on choice of valve head

#### Net Weight







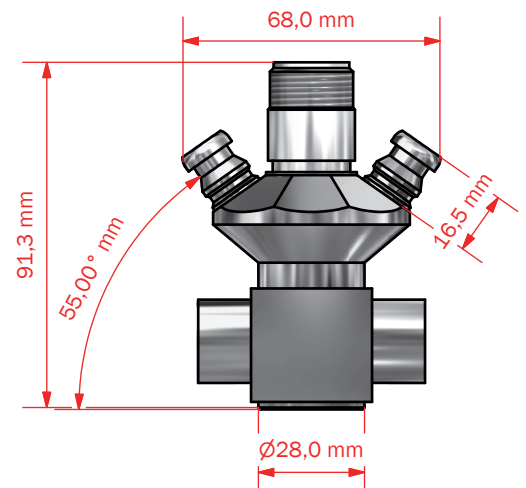
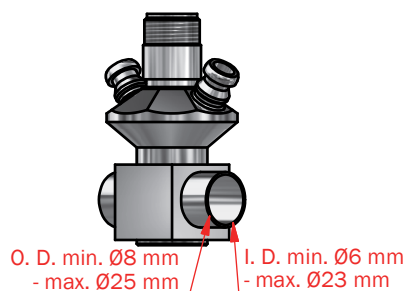
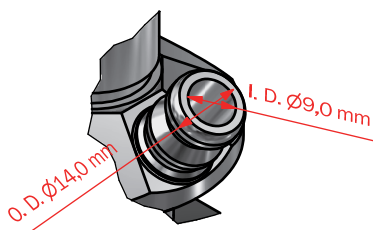
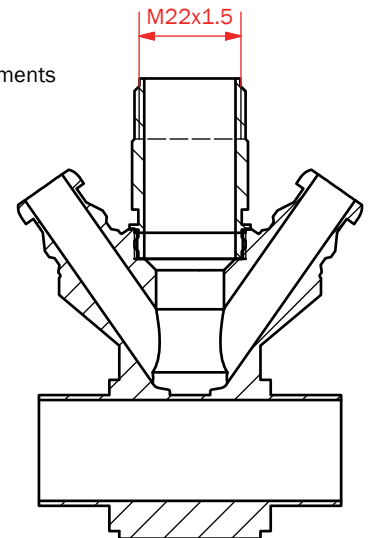



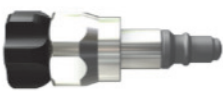



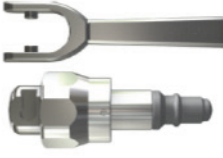
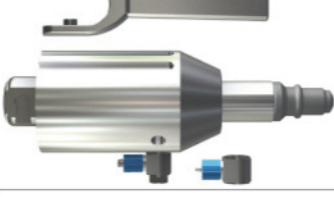
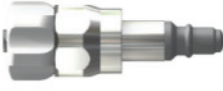

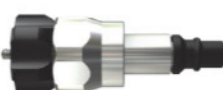
· Kg/lbs                              0.484 kg / 1,06 lbs

#### Spareparts

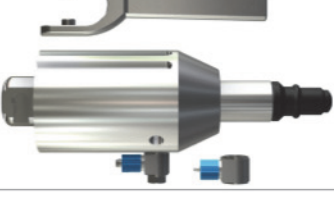
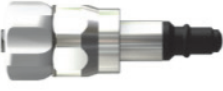
778501                              PARTS FOR W9 850001/03/11/14/21/27/28/36

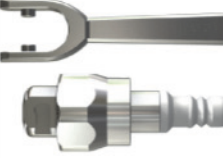
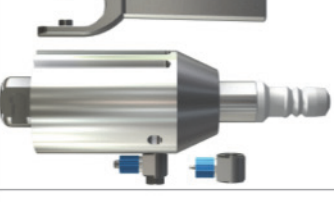

## W 9 HEADS

	Type H Turn knob	Type H Turn knob with Microport option	Type K Key ring	Type K Key ring with Microport option	Key Ring for valve head	Type Q Lever handle	Type N Lever handle Pneumatic	Type B No spring 0-1.2 bar(g)
Silicone	 600041	 600048	 600042	 600049	 600076	 600043	 600044	 600047
EPDM	 600041E	 600048E	 600042E	 600049E	 600076	 600043E	 600044E	 600047E
PTFE	 855541	<i>Not available</i>	 855542	<i>Not available</i>	 600076	 855543	 855544	 855547