

VALVE BODY W9 TYPE P NW25

ART. NO. 850014

GENERAL

- The KEOFIT CLASSIC W9 Sampling Valve is the original and leading sterilizable sampling valve in the world. Used in all industries for decades. + 320 standard valve configurations. Unique serial no. for each valve ("E" = internal electro polish).
- Valve body designed for sampling of liquids with a viscosity of up to approx. 1.000 cP containing no particles larger than Ø3 mm. Sampling of more viscous liquids is possible, only will it take longer (depending on process pressure).
- Cleaning/sterilizing: Between batches: Valve in open position: Cleanable by means of CIP using the detergent solution suitable for the actual process media (EHEDG certificate available). Between samples: Valve in its normal closed position: cleanable by CIP as "Between batches" or the valve may be sterilized by means of steam SIP (EHEDG test report available) or chemical SIP using a procedure appropriate to the actual circumstances. For further advice, please contact Keofitt.
- The sampling valve can be used for any process sampling for microbiological, chemical and/or physical analysis.

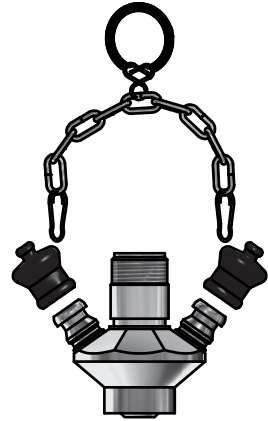

FEATURES

- Installation: Pipe welding
- Operation: Depending on choice of valve head
- Inlet / Outlet: Hose piece
- Membrane: Depending on choice of valve head

CERTIFICATION*

· EHEDG CIP · Conforms to 3-A · 3.1 Material Certificate · EU 1935/2004 · Ra Cert. incl. measurements

TECHNICAL DATA

Material (product contact)

· Steel parts AISI 316L (1.4404)

Material (without product contact)

· Steel parts AISI 316L (1.4404)
 · Rubber cap EPDM (EPL-60 - black)
 · Stainless steel chain AISI 316L (1.4404)

Surface Treatment

· Outside Electropolished Ra <= 1.2 µm
 · Inside (wetted surface) Electropolished Ra <= 0.5 µm
 · Process connection Electropolished Ra <= 0.5 µm

Pressure & Temperature

· Pressure Depending on choice of valve head
 · Temperature Depending on choice of valve head
 · Air supply Depending on choice of valve head

Net Weight







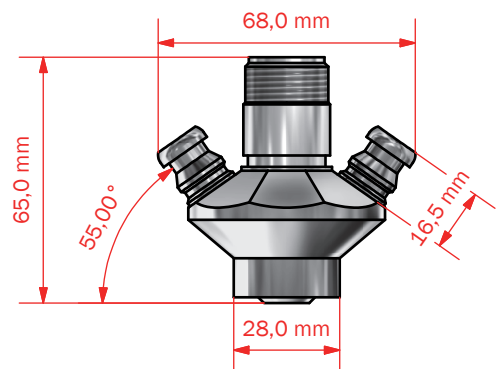
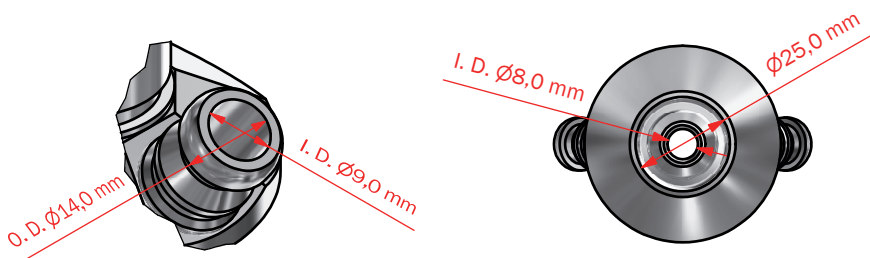
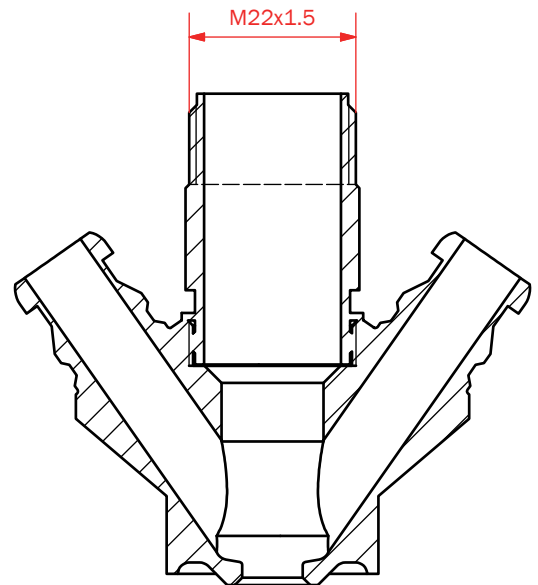





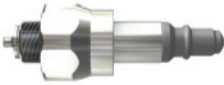





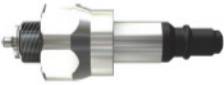

· Kg/lbs 0,306 kg /0,67 lbs

Spareparts

778501 SPARE PARTS FOR W9 850001/03/11/14/21/36



W 9 HEADS

	Type H Turn knob	Type H Turn knob with Microport option	Type K Key ring	Type K Key ring with Microport option	Key Ring for valve head	Type Q Lever handle	Type N Lever handle Pneumatic	Type B No spring 0-1.2 bar(g)
Silicone	 600041	 600048	 600042	 600049	 600076	 600043	 600044	 600047
EPDM	 600041E	 600048E	 600042E	 600049E	 600076	 600043E	 600044E	 600047E
PTFE	 855541	<i>Not available</i>	 855542	<i>Not available</i>	 600076	 855543	 855544	 855547