

VALVE BODY W9 TYPE C2"

ART. NO. 850003

GENERAL

- The KEOFIT CLASSIC W9 Sampling Valve is the original and leading sterilizable sampling valve in the world. Used in all industries for decades. + 320 standard valve configurations. Unique serial no. for each valve ("E" = internal electro polish).
- Valve body designed for sampling of liquids with a viscosity of up to approx. 1.000 cP containing no particles larger than Ø3 mm. Sampling of more viscous liquids is possible, only will it take longer (depending on process pressure).
- Cleaning/sterilizing: Between batches: Valve in open position: Cleanable by means of CIP using the detergent solution suitable for the actual process media (EHEDG certificate available). Between samples: Valve in its normal closed position: cleanable by CIP as "Between batches" or the valve may be sterilized by means of steam SIP (EHEDG test report available) or chemical SIP using a procedure appropriate to the actual circumstances. For further advice, please contact Keofitt.
- The sampling valve can be used for any process sampling for microbiological, chemical and/or physical analysis.



FEATURES

- Installation: Clamp connection 2"
- Operation: Depending on choice of valve head
- Inlet / Outlet: Hose piece
- Membrane: Depending on choice of valve head

CERTIFICATION*

· EHEDG CIP · Conforms to 3-A · 3.1 Material Certificate · EU 1935/2004 · Ra Cert. incl. measurements

TECHNICAL DATA

Material (product contact)

· Steel parts AISI 316L (1.4404)

Material (without product contact)

· Steel parts AISI 316L (1.4404)
· Rubber cap EPDM (black)
· Stainless steel chain AISI 316L (1.4404)

Surface Treatment

· Outside Electropolished Ra <= 1.2 µm
· Inside (wetted surface) Electropolished Ra <= 0.5 µm
· Process connection Electropolished Ra <= 0.5 µm

Pressure & Temperature

· Pressure Depending on choice of valve head
· Temperature Depending on choice of valve head
· Air supply Depending on choice of valve head

Net Weight







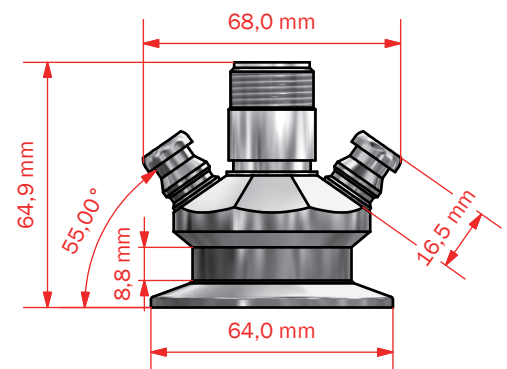
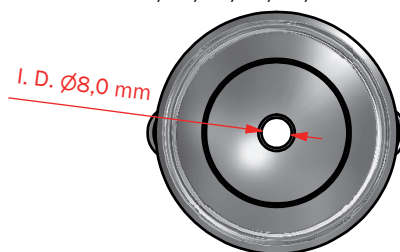
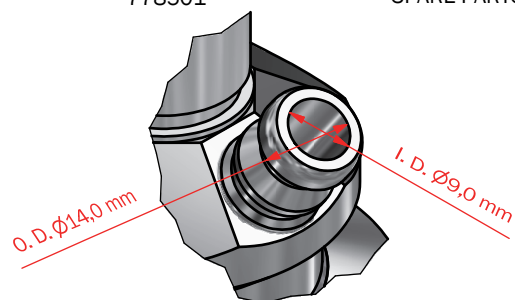
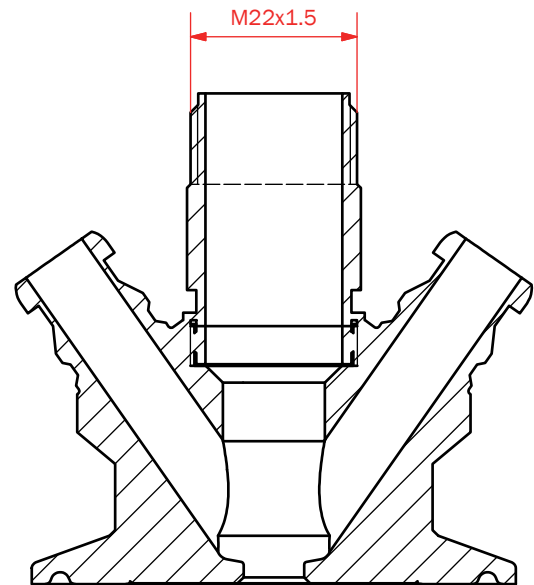















· Kg/lbs 0.479 kg / 1,05 lbs

Spareparts

778501 SPARE PARTS FOR W9 850001/03/11/14/21/36



W 9 HEADS

Silicone	<p>Type H Turn knob</p>  <p>600041</p>	<p>Type H Turn knob with Microport option</p>  <p>600048</p>	<p>Type K Key ring</p>  <p>600042</p>	<p>Type K Key ring with Microport option</p>  <p>600049</p>	<p>Key Ring for valve head</p>  <p>600076</p>	<p>Type Q Lever handle</p>  <p>600043</p>	<p>Type N Lever handle Pneumatic</p>  <p>600044</p>	<p>Type B No spring 0-1.2 bar(g)</p>  <p>600047</p>
EPDM	<p>Type H</p>  <p>600041E</p>	<p>Type H</p>  <p>600048E</p>	<p>Type K</p>  <p>600042E</p>	<p>Type K</p>  <p>600049E</p>	<p>Key Ring</p>  <p>600076</p>	<p>Type Q</p>  <p>600043E</p>	<p>Type N</p>  <p>600044E</p>	<p>Type B</p>  <p>600047E</p>
PTFE	<p>Type H</p>  <p>855541</p>	<p><i>Not available</i></p>	<p>Type K</p>  <p>855542</p>	<p><i>Not available</i></p>	<p>Key Ring</p>  <p>600076</p>	<p>Type Q</p>  <p>855543</p>	<p>Type N</p>  <p>855544</p>	<p>Type B</p>  <p>855547</p>