





SIMPLEX VALVE TYPE N C1"/NA, PTFE



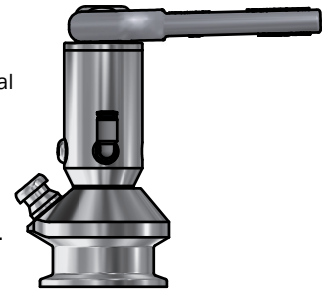

ART. NO. 832244PTFE

GENERAL

-  The KEOFITT SIMPLEX Sampling Valve is our CIP-able sampling valve for less demanding applications. Replaces non-hygienic sampling cocks. + 20 different configurations available. Unique serial no. for each valve ("E" = internal electro polish).
-  The sampling valve can be used for any process sampling for chemical and/or physical analysis.
-  The valve can be cleaned by means of CIP (EHEDG certified). Not recommended for autoclave due to plastic parts.
-  Designed for sampling of liquids with a viscosity of up to approx. 1.000 cP containing no particles larger than Ø3 mm. Sampling of more viscous liquids is possible, only will it take longer (depending on process pressure).



FEATURES

-  Installation: Clamp connection 1"/NA
-  Operation: Pneumatically operated/lever handle
-  Head assembly: Hand tight using a tommy bar or maximum 15 Nm. Tommy bar included
-  Outlet: Hose piece
-  Membrane: PTFE (TFM 1600 - white)

CERTIFICATION*

· Conforms to 3-A · EHEDG CIP · 3.1 Material Certificate · EU 1935/2004 · Ra Cert. incl. measurements

TECHNICAL DATA

Material (product contact)

- Steel parts AISI 316L (1.4404)
- Membrane PTFE (TFM 1600 - white)

Material (without product contact)

- Steel parts AISI 316L (1.4404)
- Steel parts AISI 303L (1.4305)
- Lever handle AISI 316 (1.4404)

Membrane

- Article & Certification* PTFE, WHITE (# 850055) FDA · USP · EU 1935/2004

Surface Treatment

- Outside Electropolished Ra <= 1.2 µm
- Inside & process Electropolished Ra <= 0.5 µm

Pressure & Temperature

- Pressure 0 - 6 bar (g) / 0 - 87 psi (g)
- Temperature 1 - 150 °C / 34 - 302 ° F
- Air supply 5 - 7 bar (g) / 73 - 102 psi (g)

Net Weight

- Kg/lbs 0,856 kg / 1,33 lbs

Spareparts

- 778344PTFE PARTS FOR SIMPLEX TYPE N 01/11/21/22

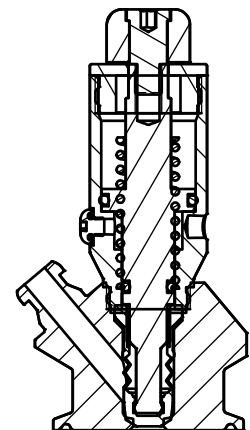

Festo Fitting
QSML-M5-4

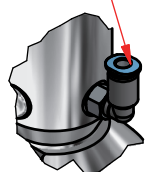

I. D. Ø7,0 mm
O. D. Ø14,0 mm

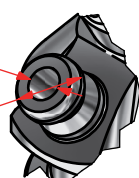

I. D. Ø8,0 mm

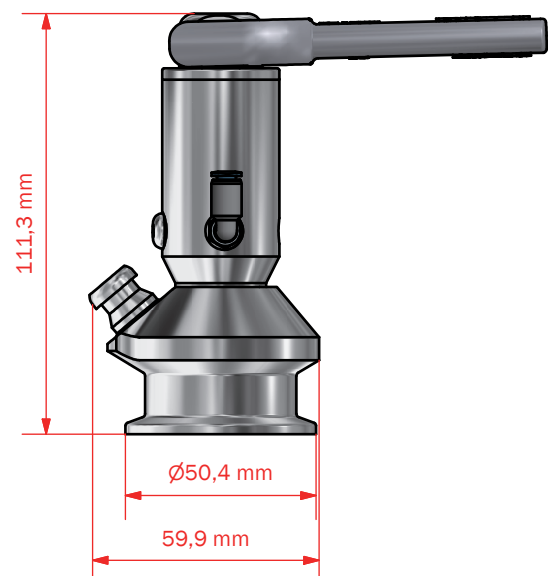
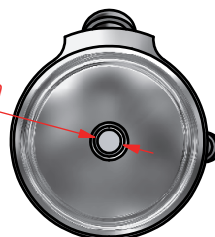

		Manual Valve					Pneumatic Valve				
		Tank welding	Pipe welding	Mini clamp	1" Clamp	Ø68 varivent	Tank welding	Pipe welding	Mini clamp	1" Clamp	Ø68 varivent
Hose Piece	Silicone	830141	831141	832141	832241	830941	830144	831144	832144	832244	830944
	EPDM	830141EPDM	831141EPDM	832141EPDM	832241EPDM	830941EPDM	830144EPDM	831144EPDM	832144EPDM	832244EPDM	830944EPDM
	PTFE	830141PTFE	831141PTFE	832141PTFE	832241PTFE	830941PTFE	830144PTFE	831144PTFE	832144PTFE	832244PTFE	830944PTFE
Welding Liner	Silicone	830141.2	831141.2				On request				
	EPDM	830141.2EPDM	831141.2EPDM								
	PTFE	830141.2PTFE	831141.2PTFE								

On request

On request