









## SIMPLEX VALVE TYPE 1"C/N

ART. NO. 832244epdm

### GENERAL

-  The KEOFITT SIMPLEX Sampling Valve is KEOFITT's low-cost CIP-able sampling valve for less demanding applications. Typically used replacing existing non-hygienic sampling cocks. More than 20 different configurations available.
-  The sampling valve can be used for any process sampling for chemical and/or physical analysis
-  The valve can be cleaned by means of CIP through the open valve seat
-  The product to be sampled should have a maximum viscosity of 0-1.000 cP and should not contain particles larger than 2 mm diameter

### FEATURES

-  Installation: Clamp connection 1" N/A (DIN)
-  Operation: Pneumatically operated
-  Outlet: Hose piece - other types are available as accessories
-  Membrane: EPDM (PTFE & Silicone available)

### CERTIFICATION

· Conform to 3-A · EHEDG CIP · 3.1 Material Certificate · EU 1935/2004 · RA certificate

### TECHNICAL DATA

#### Material (product contact)

· Steel parts	AISI 316L (1.4404)
· Membrane	EPDM
· O-ring	Silicone

#### Material (without product contact)

· Steel parts	AISI 316L (1.4404)
· Steel parts	AISI 303L (1.4305)

#### Surface Treatment

· Outer Surface	Machined
· Inner Surface	<= Ra 0.8 µm

#### Pressure & Temperature

· Pressure	0 - 6 bar (g) / 0 - 87 psi (g)
· Temperature	1 - 130° C / 34 - 266° F
· Air Supply	4 - 6 bar (g) / 58 - 87 psi (g)









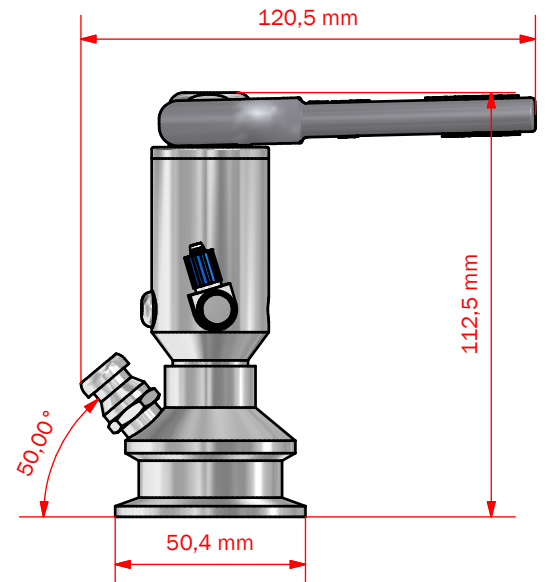
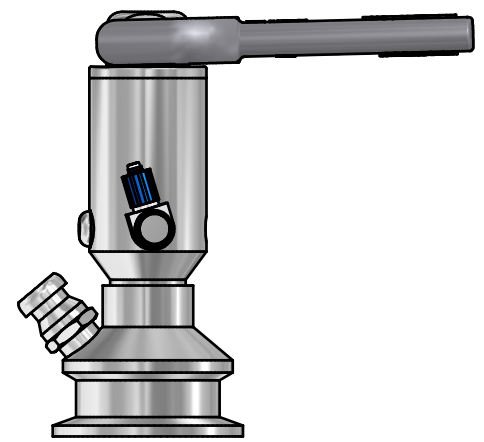
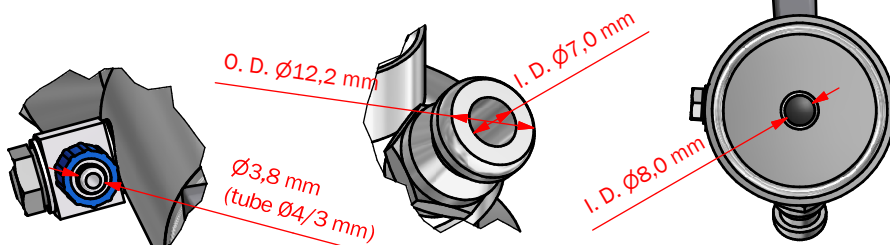





#### Net Weight

· Kg/lbs	N/A / 1,31 lbs
----------	----------------

#### Spareparts

300119	O-ring
550170	Screw for air fitting
550184	O-ring
600052	Membrane
600839	Swivel elbow for air cylinder
800830	O-ring



		Manual Valve				Pneumatic Valve			
		Pipe welding	Tank welding	1/2" Clamp connection	1" Clamp connection	Pipe welding	Tank welding	1" Clamp connection	1" Clamp connection
	Hose Piece								
	Silicone	831141	830141	832141	832241	831144	830144	832144	832144
	EPDM	831141EPDM	830141EPDM	832141EPDM	832241EPDM	831144EPDM	830144EPDM	832144EPDM	832144EPDM
	PTFE	831141PTFE	830141PTFE	832141PTFE	832241PTFE	831144PTFE	830144PTFE	832144PTFE	832144PTFE
<b>Parts &amp; Accessories for Simplex™</b>									
									
		830107	830121	830825	600825	600051	600052	850055	