

SIMPLEX™ Manual Valve - pipe welding

ART. NO. 831141EPDM

GENERAL



The CIP-able and drainable sampling valve - based on the well known Keofitt® design. The valve has one outlet and is used in the part of the process where it is not necessary to sterilise the valve before and after sampling. The valve is available in a manual and a pneumatic version.



The sampling valve can be used at any process for taking out any samples for chemical and/or physical analysis.



The valve can be cleaned by means of CIP through the open valve seat.



The product to be sampled should have a maximum viscosity of 1000 cP and should not contain particles larger than 3 mm. diameter.

FEATURES



To be welded directly into a pipe line.



Manually operated by means of turn knob



The outlet is a hose piece - other types are available as accessories.



EPDM (PTFE & Silicone available)

CERTIFICATION



EHEDG CIP

3.1

3.1 Material Certificate



Conform to 3-A Sanitary Standards



In accordance with FDA §177.2600

TECHNICAL DATA

Material (process contact)

- Steel parts AISI 316L (1.4404)
- Membrane EPDM
- O-ring Silicone

Material (without process contact)

- Steel parts AISI 316L (1.4404)
- Steel parts AISI 303 (1.4305)
- Turn knob Delrin Acetal Resin

Surface treatment

- Outer surface Machined
- Inner surface $\leq Ra\ 0.8\ \mu m$

Pressure & temperature

- Pressure 0-6 bar / 0 - 87 psi
- Temperature 1-130 °C / 34°F - 266°F

Net weight

- Kg/lb 0,30 / 0,66

Spareparts

- Membrane 600052 (EPDM)
- O-ring 830825

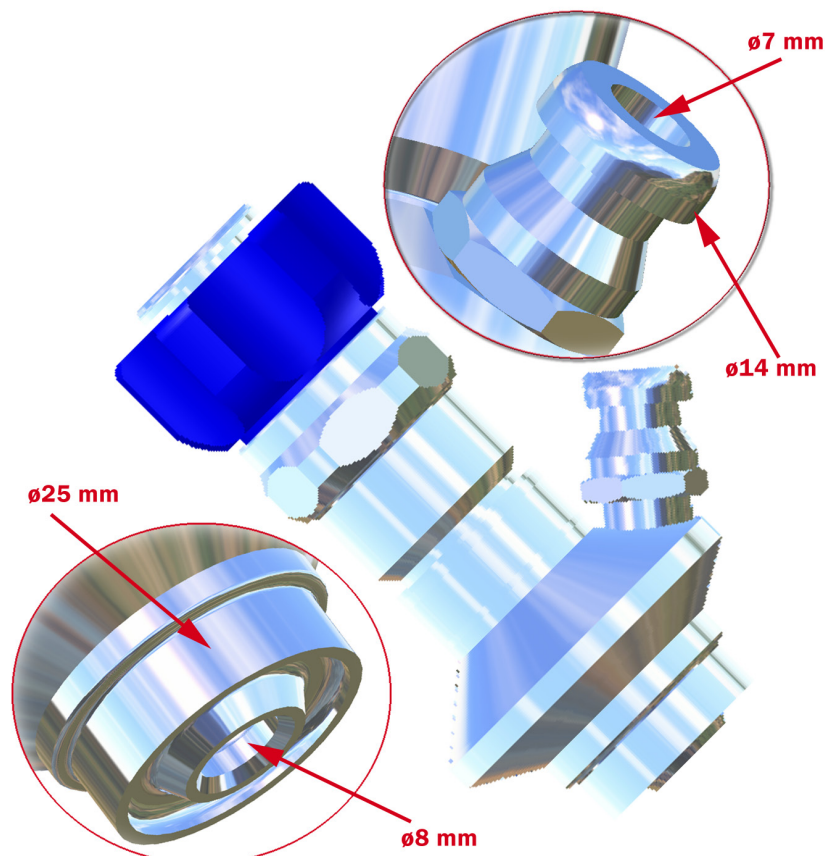

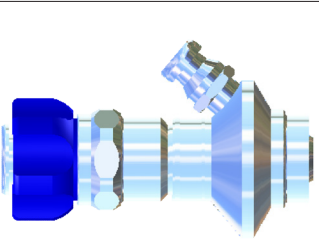
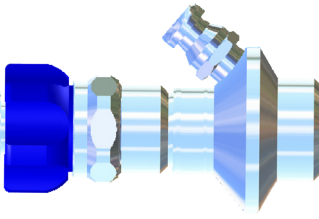
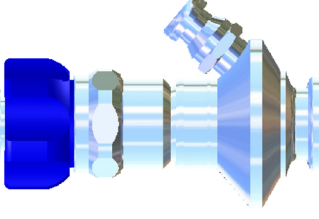
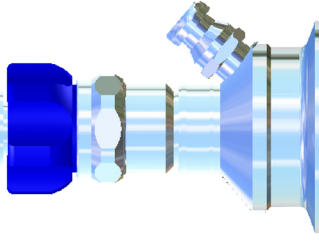
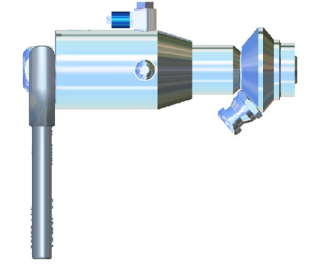
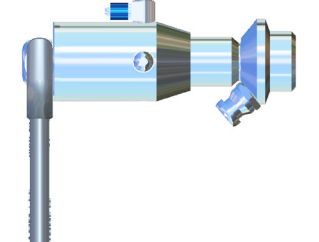
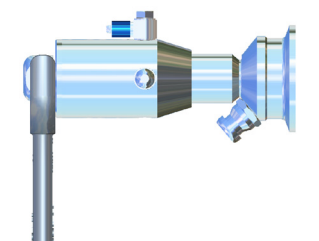
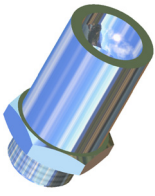
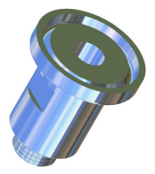
		Manual Valve			Pneumatic Valve			
		Pipe welding	Tank welding	1/2" Clamp connection	1" Clamp connection	Pipe welding	Tank welding	1" Clamp connection
	Hose Piece							
		831141	830141	832141	832241	811144	810144	812144
Silicone		831141EPDM	830141EPDM	832141EPDM	832241EPDM	811144EPDM	810144EPDM	812144EPDM
EPDM		831141PTFE	830141PTFE	832141PTFE	832241PTFE	811144PTFE	810144PTFE	812144PTFE
PTFE								
Accessories								
	Outlet							
		830107	830121					