





## SIMPLEX VALVE TYPE P/H, PTFE



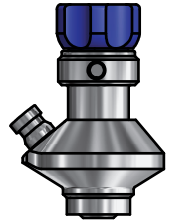

ART. NO. 831141.2PTFE

### GENERAL

-  The KEOFITT SIMPLEX Sampling Valve is our CIP-able sampling valve for less demanding applications. Replaces non-hygienic sampling cocks. + 20 different configurations available. Unique serial no. for each valve ("E" = internal electro polish).
-  The sampling valve can be used for any process sampling for chemical and/or physical analysis.
-  The valve can be cleaned by means of CIP (EHEDG certified). Not recommended for autoclave due to plastic parts.
-  Designed for sampling of liquids with a viscosity of up to approx. 1.000 cP containing no particles larger than Ø3 mm. Sampling of more viscous liquids is possible, only will it take longer (depending on process pressure).



### FEATURES

-  Installation: Pipe welding
-  Operation: Turn knob - spring to close (open left)
-  Head assembly: Hand tight using a tommy bar or maximum 15 Nm. Tommy bar included
-  Outlet: Welding end
-  Membrane: PTFE (TFM 1600 - white)

### CERTIFICATION\*

· Conforms to 3-A · EHEDG CIP · 3.1 Material Certificate · EU 1935/2004 · Ra Cert. incl. measurements

### TECHNICAL DATA

#### Material (product contact)

- Steel parts                   AISI 316L (1.4404)
- Membrane                   PTFE (TFM 1600 - white)

#### Material (without product contact)

- Steel parts                   AISI 316L (1.4404)
- Steel parts                   AISI 303L (1.4305)
- Knob                         HDPE (blue)

#### Membrane

- Article & Certification\*   PTFE, WHITE (# 850055) FDA · USP · EU 1935/2004

#### Surface Treatment

- Outside                      Electropolished Ra <= 1.2 µm
- Inside & process           Electropolished Ra <= 0.5 µm

#### Pressure & Temperature

- Pressure                     0 - 6 bar (g) / 0 - 87 psi (g)
- Temperature               1 - 150° C / 34 - 302° F
- Air supply                  -









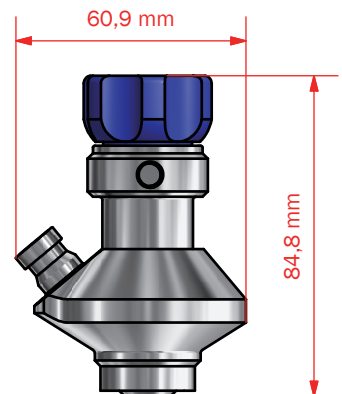
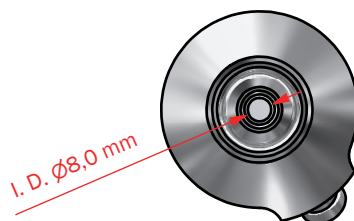
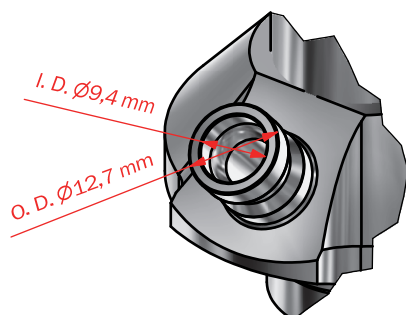
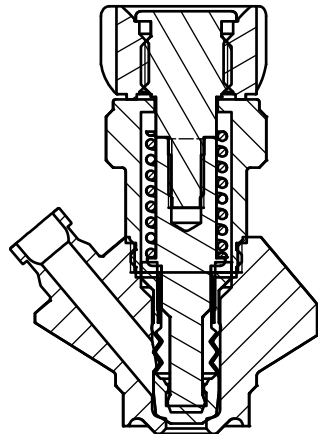



















































#### Net Weight

- Kg/lbs                       0,501 kg / 0,80 lbs

#### Spareparts

- 778301PTFE                 PARTS FOR SIMPLEX 01/11/21/22



		Manual Valve					Pneumatic Valve				
		Tank welding	Pipe welding	Mini clamp	1" Clamp	Ø68 varivent	Tank welding	Pipe welding	Mini clamp	1" Clamp	Ø68 varivent
Hose Piece	PTFE										
	EPDM										
	Silicone										
Welding Liner	PTFE										
	EPDM										
	Silicone										
		830141	831141	832141	832241	830941	830144	831144	832144	832244	830944
		830141.2	831141.2	832141.2	832241.2	830941.2	830144.2	831144.2	832144.2	832244.2	830944.2
		830141.2EPDM	831141.2EPDM	832141.2EPDM	832241.2EPDM	830941.2EPDM	830144.2EPDM	831144.2EPDM	832144.2EPDM	832244.2EPDM	830944.2EPDM
		830141.2PTFE	831141.2PTFE	832141.2PTFE	832241.2PTFE	830941.2PTFE	830144.2PTFE	831144.2PTFE	832144.2PTFE	832244.2PTFE	830944.2PTFE
		On request					On request				

On request

On request