





SIMPLEX VALVE TYPE T/N



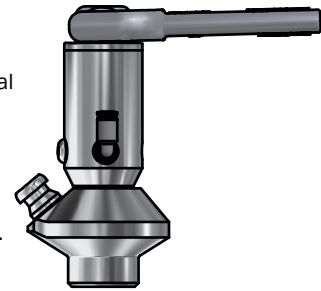

ART. NO. 830144

GENERAL

-  The KEOFITT SIMPLEX Sampling Valve is our CIP-able sampling valve for less demanding applications. Replaces non-hygienic sampling cocks. + 20 different configurations available. Unique serial no. for each valve ("E" = internal electro polish).
-  The sampling valve can be used for any process sampling for chemical and/or physical analysis.
-  The valve can be cleaned by means of CIP (EHEDG certified). Not recommended for autoclave due to plastic parts.
-  Designed for sampling of liquids with a viscosity of up to approx. 1.000 cP containing no particles larger than Ø3 mm. Sampling of more viscous liquids is possible, only will it take longer (depending on process pressure).



FEATURES

-  Installation: Tank welding
-  Operation: Pneumatically operated/lever handle
-  Head assembly: Hand tight using a tommy bar or maximum 15 Nm. Tommy bar included
-  Outlet: Hose piece
-  Membrane: Silicone (QBF-65 - grey)

CERTIFICATION*

· Conforms to 3-A · EHEDG CIP · 3.1 Material Certificate · EU 1935/2004 · Ra Cert. incl. measurements

TECHNICAL DATA

Material (product contact)

- Steel parts AISI 316L (1.4404)
- Membrane Silicone (QBF-65 - grey)

Material (without product contact)

- Steel parts AISI 316L (1.4404)
- Steel parts AISI 303L (1.4305)
- Lever handle AISI 316 (1.4404)

Membrane

- Article & Certification* SILICONE, GREY (# 600051) FDA · USP · EU 1935/2004

Surface Treatment

- Outside Electropolished Ra <= 1.2 µm
- Inside & process Electropolished Ra <= 0.5 µm

Pressure & Temperature

- Pressure 0 - 6 bar (g) / 0 - 87 psi (g)
- Temperature 1 - 130 °C / 34 - 266 ° F
- Air supply 5 - 7 bar (g) / 73 - 102 psi (g)

Net Weight

- Kg/lbs 0,765 kg / 1,36 lbs





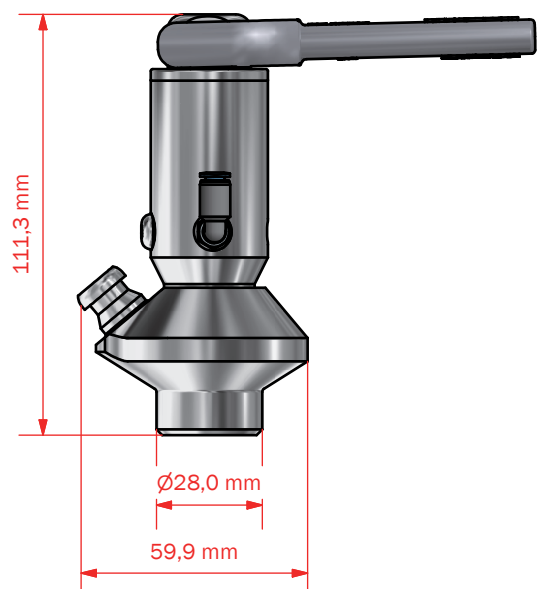
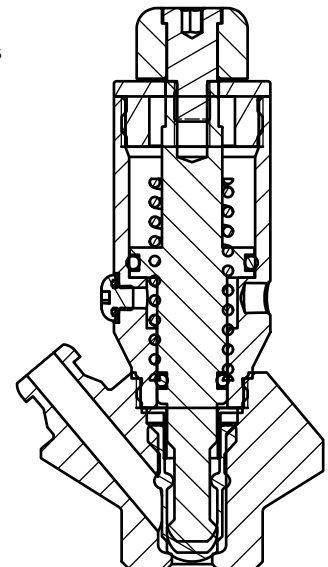



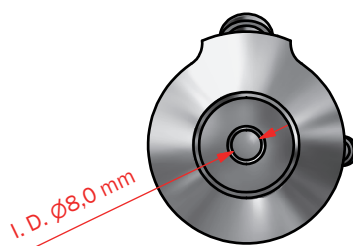
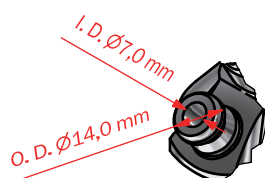



















































Spareparts

- 778344 PARTS FOR SIMPLEX TYPE N 01/11/21/22



Festo Fitting QSML-M5-4



| | | Manual Valve | | | | | Pneumatic Valve | | | | |
|---------------|----------|--|--|--|--|--|--|--|--|--|--|
| | | Tank welding | Pipe welding | Mini clamp | 1" Clamp | Ø68 varivent | Tank welding | Pipe welding | Mini clamp | 1" Clamp | Ø68 varivent |
| Hose Piece | PTFE |  |  |  |  |  |  |  |  |  |  |
| | EPDM |  |  |  |  |  |  |  |  |  |  |
| | Silicone |  |  |  |  |  |  |  |  |  |  |
| Welding Liner | PTFE |  |  |  |  |  |  |  |  |  |  |
| | EPDM |  |  |  |  |  |  |  |  |  |  |
| | Silicone |  |  |  |  |  |  |  |  |  |  |
| | | 830141 | 831141 | 832141 | 832241 | 830941 | 830144 | 831144 | 832144 | 832244 | 830944 |
| | | 830141 | 831141 | 832141 | 832241 | 830941 | 830144 | 831144 | 832144 | 832244 | 830944 |
| | | 830141 | 831141 | 832141 | 832241 | 830941 | 830144 | 831144 | 832144 | 832244 | 830944 |
| | | 830141.2 | 831141.2 | 832141.2 | 832241.2 | 830941.2 | 830144 | 831144 | 832144 | 832244 | 830944 |
| | | 830141.2EPDM | 831141.2EPDM | 832141.2EPDM | 832241.2EPDM | 830941.2EPDM | 830144 | 831144 | 832144 | 832244 | 830944 |
| | | 830141.2PTFE | 831141.2PTFE | 832141.2PTFE | 832241.2PTFE | 830941.2PTFE | 830144 | 831144 | 832144 | 832244 | 830944 |
| | | On request | | | | | On request | | | | |
| | | | | | | | | | | | |
| | | | | | | | | | | | |

On request

On request