





VALVE HEAD W9 TYPE N, EPDM

ART. NO. 600044E

GENERAL

-  The KEOFITT CLASSIC W9 Sampling Valve is the original and leading sterilizable sampling valve in the world. Used in all industries for decades. + 320 standard valve configurations. Unique serial no. for each valve ("E" = internal electro polish).
-  The sampling valve can be used for any process sampling for microbiological, chemical and/or physical analysis.
-  Cleaning/sterilizing: Between batches: Valve in open position: Cleanable by means of CIP using the detergent solution suitable for the actual process media (EHEDG certificate available). Between samples: Valve in its normal closed position: cleanable by CIP as "Between batches" or the valve may be sterilized by means of steam SIP (EHEDG test report available) or chemical SIP using a procedure appropriate to the actual circumstances. For further advice, please contact Keofitt.
-  Designed for sampling of liquids with a viscosity of up to approx. 1.000 cP containing no particles larger than Ø3 mm. Sampling of more viscous liquids is possible, only will it take longer (depending on process pressure).

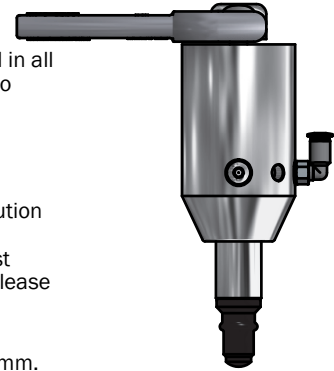

FEATURES

-  Installation: Threaded connection
-  Operation: Pneumatically operated/lever handle
-  Inlet / Outlet: Depending on choice of valve body
-  Membrane: EPDM (EPL-60 - black)

CERTIFICATION*

· Conforms to 3-A · EHEDG CIP · EU 1935/2004

TECHNICAL DATA

Material (product contact)

· Membrane EPDM (EPL-60 - black)

Material (without product contact)

· Steel parts AISI 303L (1.4305)
· Steel parts AISI 316L (1.4404)

Membrane

· Article EPDM, BLACK (# 600052)
· Certification* FDA · USP · EU 1935/2004

Pressure & Temperature

· Pressure 0 - 6 bar (g) / 0 - 87 psi (g)
· Temperature 1 - 130° C / 34 - 266° F
· Air supply 4 - 7 bar (g) / 58 - 101 psi (g)

Net Weight

· Kg/lbs 0,918 kg / 2,02 lbs





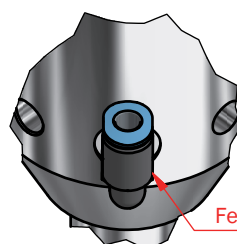
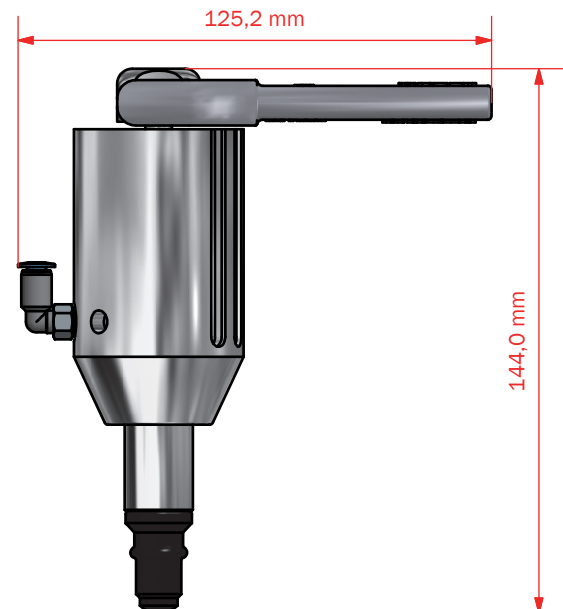
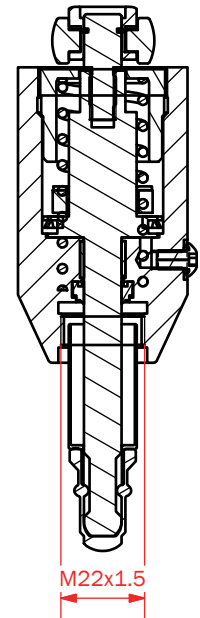















Spareparts

776044EPDM PARTS FOR W9 HEAD 600044E



Festo Fitting QSM-L-M5-4

W 9 HEADS

		Connection bodies						Welding bodies			
		Thread	Clamp 2"	Clamp 1"	Mini Clamp	Varivent Ø68	Varivent Ø50	Pipe Welding	Pipe Welding	Tank Welding	
	Hoses Piece	 850031	 850003	 850021	 850036	 850009	 850008	 850014	 850011	 850001	
	Mini Clamp	<i>On request</i>	 850005	 850022  850025	 850039	 850013	<i>On request</i>	<i>On request</i>	 850010	 850006	
	Thread M16x1,5	<i>On request</i>	<i>On request</i>	 850024	<i>On request</i>	<i>On request</i>	<i>On request</i>	 850018	 850016	 850015	