





## VALVE HEAD M4 TYPE N/Adjustable

ART. NO. 405545

### GENERAL

-  The KEOFITT CLASSIC M4 Sampling Valve is the smallest KEOFITT sampling valve. Used in all industries for decades. +120 standard valve configurations. Unique serial no. for each valve ("E" = internal electro polish).
-  The sampling valve can be used for any process sampling for microbiological, chemical and/or physical analysis.
-  Cleaning/sterilizing: Between batches: Valve in open position: Cleanable by means of CIP using the detergent solution suitable for the actual process media (EHEDG certificate available). Between samples: Valve in its normal closed position: cleanable by CIP as "Between batches" or the valve may be sterilized by means of steam SIP (EHEDG test report available) or chemical SIP using a procedure appropriate to the actual circumstances. For further advice, please contact Keofitt.
-  Designed for sampling of liquids with a viscosity of up to approx. 100 cP containing no particles larger than Ø1,5 mm. Sampling of more viscous liquids is possible, only will it take longer (depending on process pressure).

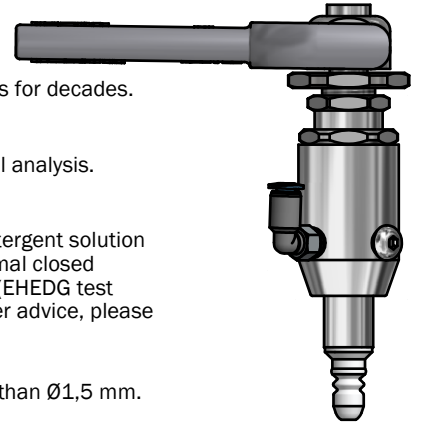

### FEATURES

-  Installation: Threaded socket connection M16x1
-  Operation: Pneumatically operated/lever handle
-  Inlet / Outlet: Depending on choice of valve body
-  Membrane: PTFE (TFM 1600 - white)

### CERTIFICATION\*

· Conforms to 3-A · EHEDG CIP · EU 1935/2004

### TECHNICAL DATA

#### Material (product contact)

· Membrane PTFE (TFM 1600 - white)

#### Material (without product contact)

· Steel parts AISI 303L (1.4305)  
· Steel parts AISI 316L (1.4404)  
· Magnet Neodyn

#### Membrane

· Article PTFE, WHITE (# 400055)  
· Certification\* FDA · USP · EU 1935/2004

#### Pressure & Temperature

· Pressure 0 - 6 bar (g) / 0 - 87 psi (g)  
· Temperature 1 - 150 °C / 34 - 302 ° F  
· Air supply 4 - 7 bar (g) / 58 - 101 psi (g)

#### Net Weight

· Kg/lbs 0.347 kg / 0,61 lbs





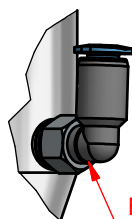
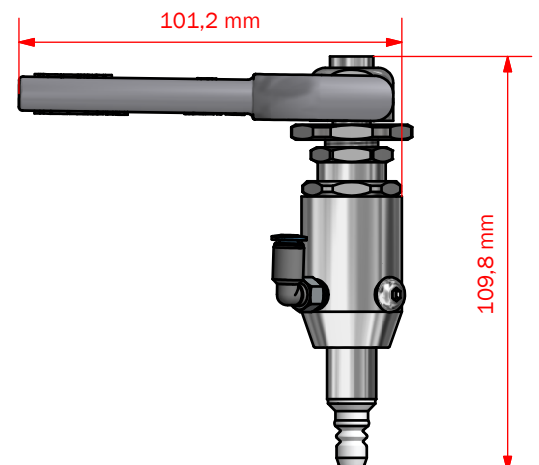
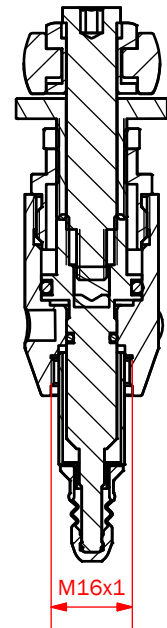



#### Spareparts

774044PTFE PARTS FOR M4 HEAD 405544



Festo Fitting QSML-M5-4

**M 4 BODIES**

		<b>Connection bodies</b>					<b>Welding bodies</b>					
		Thread M28x1,5	Clamp 1"	Clamp 1/2"	Varivent Ø68	Varivent Ø50	Pipe Welding NW25	Pipe Welding 1"	Tank Welding Ø28			
	Hose Piece											
	Mini Tri-Clamp	400031	400022	400021	400009	400010	400014	400011	400001			
	Thread M12x0,75	Not available	Not available	Not available	Not available	Not available	Not available	Not available	Not available			