





## VALVE HEAD M4 TYPE N (Q) (PTFE)

ART. NO. 405544

### GENERAL

-  The KEOFITT CLASSIC M4 Sampling Valve is the smallest KEOFITT sampling valve. Used in all industries for decades. +120 standard valve configurations. Unique serial no. for each valve ("E" = internal electro polish).
-  The sampling valve can be used for any process sampling for microbiological, chemical and/or physical analysis.
-  **Cleaning/sterilizing:** Between batches: Valve in open position: Cleanable by means of CIP using the detergent solution suitable for the actual process media (EHEDG certificate available). Between samples: Valve in its normal closed position: cleanable by CIP as "Between batches" or the valve may be sterilized by means of steam SIP (EHEDG test report available) or chemical SIP using a procedure appropriate to the actual circumstances. For further advice, please contact Keofitt.
-  Designed for sampling of liquids with a viscosity of up to approx. 100 cP containing no particles larger than Ø1,5 mm. Sampling of more viscous liquids is possible, only will it take longer (depending on process pressure).

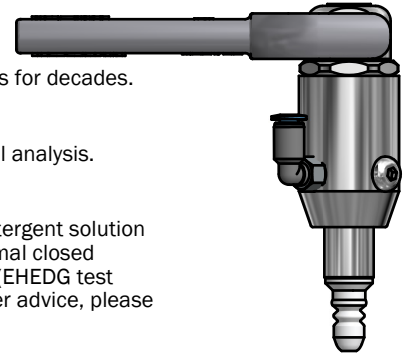

### FEATURES

-  Installation: Threaded socket connection M16x1
-  Operation: Pneumatically operated/lever handle
-  Inlet / Outlet: Depending on choice of valve body
-  Membrane: PTFE (TFM 1600 - white)

### CERTIFICATION\*

· Conforms to 3-A · EHEDG CIP · EU 1935/2004

### TECHNICAL DATA

#### Material (product contact)

· Membrane PTFE (TFM 1600 - white)

#### Material (without product contact)

· Steel parts AISI 303L (1.4305)  
· Steel parts AISI 316L (1.4404)  
· Magnet Neodyn

#### Membrane

· Article PTFE, WHITE (# 400055)  
· Certification\* FDA · USP · EU 1935/2004

#### Pressure & Temperature

· Pressure 0 - 6 bar (g) / 0 - 87 psi (g)  
· Temperature 1 - 150 °C / 34 - 302 ° F  
· Air supply 4 - 7 bar (g) / 58 - 101 psi (g)

#### Net Weight

· Kg/lbs 0,294 kg / 0,00 lbs

#### Spareparts



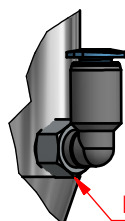
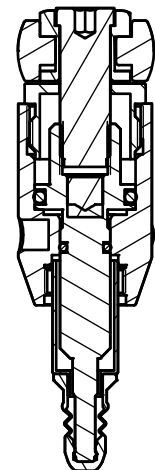



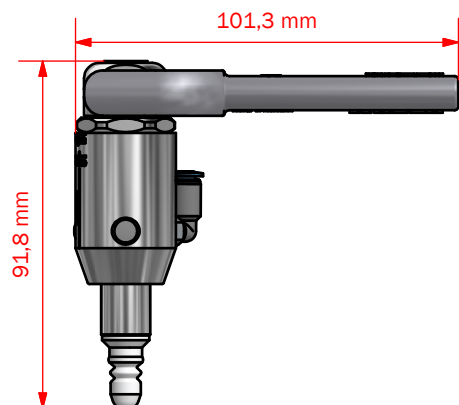

774044PTFE PARTS FOR M4 HEAD 405544



Festo Fitting QSML-M5-4



**M 4 BODIES**

		<b>Connection bodies</b>					<b>Welding bodies</b>					
		Thread M28x1,5	Clamp 1"	Clamp 1/2"	Varivent Ø68	Varivent Ø50	Pipe Welding NW25	Pipe Welding 1"	Tank Welding Ø28			
	Hose Piece											
	Mini Tri-Clamp	400031	400022	400021	400009	400010	400014	400011	400001			
		Not available	Not available	Not available	Not available	Not available	Not available	Not available	Not available			
	Thread M12x0,75	Not available	Not available	Not available	Not available	Not available	Not available	Not available	Not available			