





## VALVE HEAD M4 TYPE N/Adjustable

ART. NO. 400045

### GENERAL

-  The KEOFITT CLASSIC M4 Sampling Valve is the smallest KEOFITT sampling valve. Used in all industries for decades. +120 standard valve configurations. Unique serial no. for each valve ("E" = internal electro polish).
-  The sampling valve can be used for any process sampling for microbiological, chemical and/or physical analysis.
-  Cleaning/sterilizing: Between batches: Valve in open position: Cleanable by means of CIP using the detergent solution suitable for the actual process media (EHEDG certificate available). Between samples: Valve in its normal closed position: cleanable by CIP as "Between batches" or the valve may be sterilized by means of steam SIP (EHEDG test report available) or chemical SIP using a procedure appropriate to the actual circumstances. For further advice, please contact Keofitt.
-  Designed for sampling of liquids with a viscosity of up to approx. 100 cP containing no particles larger than Ø1,5 mm. Sampling of more viscous liquids is possible, only will it take longer (depending on process pressure).

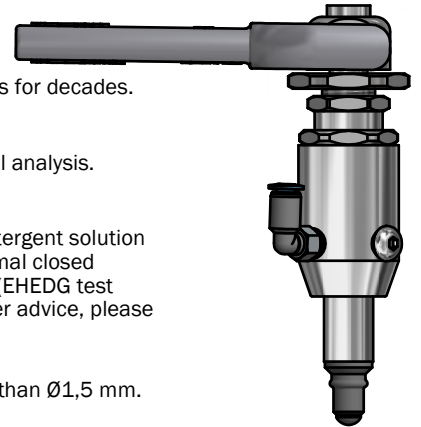

### FEATURES

-  Installation: Threaded socket connection M16x1
-  Operation: Pneumatically operated/lever handle
-  Inlet / Outlet: Depending on choice of valve body
-  Membrane: Silicone (QBF-65 - grey)

### CERTIFICATION\*

· Conforms to 3-A · EHEDG CIP · EU 1935/2004

### TECHNICAL DATA

#### Material (product contact)

· Membrane                      Silicone (QBF-65 - grey)

#### Material (without product contact)

· Steel parts                      AISI 303L (1.4305)  
· Steel parts                      AISI 316L (1.4404)  
· Magnet                          Neodyn

#### Membrane

· Article                              SILICONE, GREY (# 400051)  
· Certification\*                      FDA · USP · EU 1935/2004

#### Pressure & Temperature

· Pressure                            0 - 6 bar (g) / 0 - 87 psi (g)  
· Temperature                      1 - 130 °C / 34 - 266 ° F  
· Air supply                          4 - 7 bar (g) / 58 - 101 psi (g)

#### Net Weight







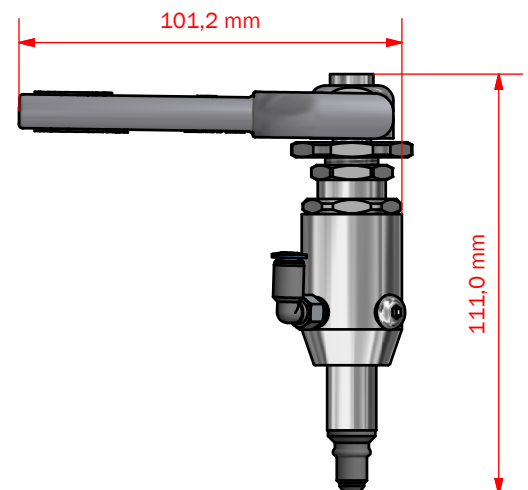
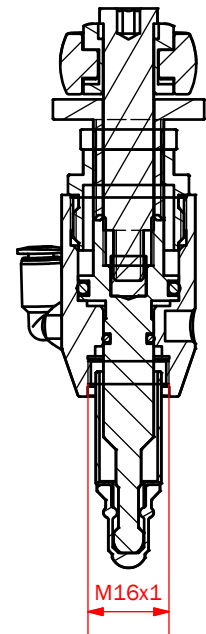

· Kg/lbs                                0.347 kg / 0,61 lbs

#### Spareparts

774044                                PARTS FOR M4 HEAD 400044



**M 4 BODIES**

		<b>Connection bodies</b>					<b>Welding bodies</b>					
		Thread M28x1,5	Clamp 1"	Clamp 1/2"	Varivent Ø68	Varivent Ø50	Pipe Welding NW25	Pipe Welding 1"	Tank Welding Ø28			
	Hose Piece											
	Mini Tri-Clamp	400031	400022	400021	400009	400010	400014	400011	400001			
	Thread M12x0,75	Not available	Not available	Not available	Not available	Not available	Not available	Not available	Not available			