

Data sheet: 320540
Item no. 320540
Adaptor for 40 mm port length

Valve body Type I
Item no.: 310002

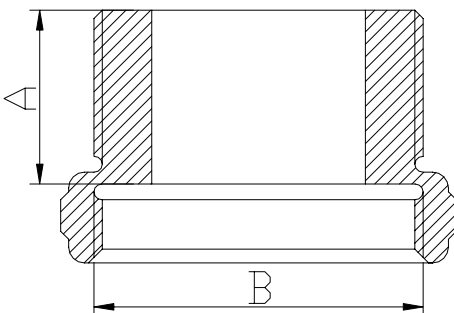
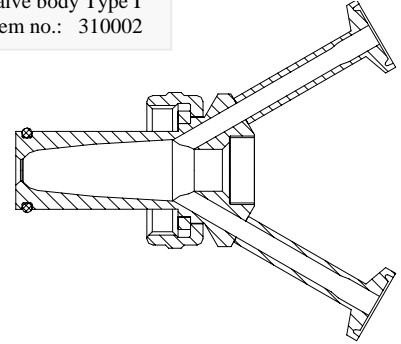

Where to use : "I" valve bodies
Material: AISI 316L (1.4404)
"I" valves to fit DN25 40mm Ports.
Key measurements
Drawing part A: 12 mm. 0.47 In.
Drawing part B: R1 ¼"
Net weight: 0.165 kg./pc 0.36lb
Available in other lengths on request.