





VALVE HEAD I52 TYPE N (Q), EPDM

ART. NO. 320044E

GENERAL

-  The KEOFIT CLASSIC "INGOLD" Sampling Valve owes its hygienic design and one-piece construction to the original KEOFIT valve. For 52 MM Ingold ports.
-  The product to be sampled should have a maximum viscosity of 0-1.000 cP and should not contain particles larger than 2 mm diameter.
-  The valve can be sterilized by means of SIP (EHEDG test) and cleaned by means of CIP (EHEDG certified). Not recommended for autoclave due to plastic parts.
-  The sampling valve can be used for any process sampling for microbiological, chemical and/or physical analysis.

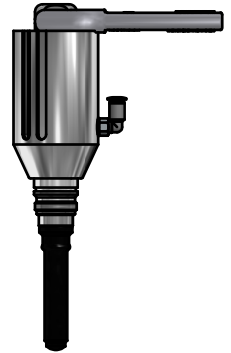

FEATURES

-  Installation: 52 mm Ingold port
-  Operation: Pneumatically operated/lever handle
-  Inlet / Outlet: Depending on choice of valve body
-  Membrane: EPDM (EPL-60 - black)

CERTIFICATION*

· Conforms to 3-A · EHEDG CIP · 3.1 Material Certificate · EU 1935/2004

TECHNICAL DATA

Material (product contact)

· Membrane EPDM (EPL-60 - black)

Material (without product contact)

· Steel parts AISI 303L (1.4305)
 · Steel parts AISI 316L (1.4404)
 · Lever handle AISI 316 (1.4404)

Membrane

· Article EPDM, BLACK (# 320052)
 · Certification* FDA · USP · EU 1935/2004

Pressure & Temperature

· Pressure 0 - 6 bar (g) / 0 - 87 psi (g)
 · Temperature 1 - 130°C / 34 - 266° F
 · Air supply 4 - 6 bar (g) / 58 - 87 psi (g)



Net Weight

· Kg/lbs 0,954 kg / 2,10 lbs

Spareparts

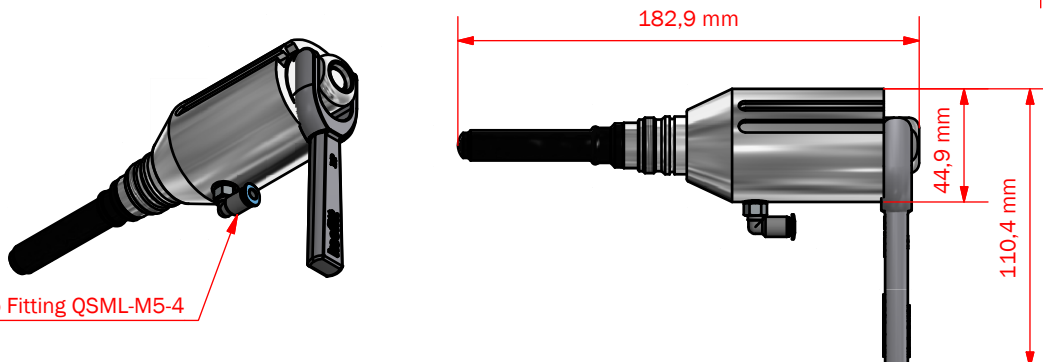
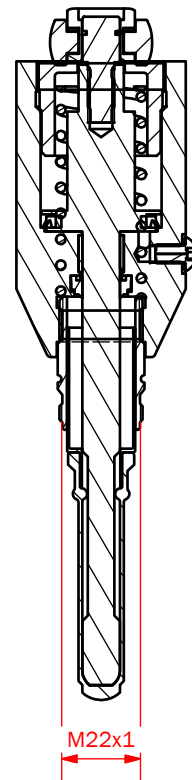
773244EPDM SPARE PARTS FOR I 52 MM HEAD 320044E

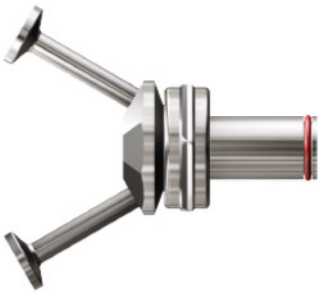

Hose Piece	Standard for 40 mm port length	Standard for 52 mm port length	
Mini Tri-Clamp	<p>Not available</p>  <p>310002</p>	<p>Not available</p>  <p>320002</p>	<p>Not available</p>  <p>320005</p>
Welding liner	<p>On request</p>	<p>On request</p>	<p>On request</p>
	<p>On request</p>	<p>On request</p>	<p>On request</p>  <p>320007</p>