





VALVE HEAD I40 TYPE Q, EPDM



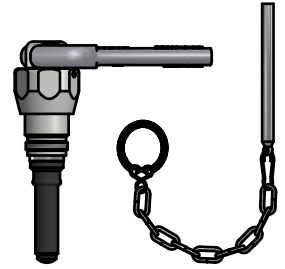

ART. NO. 310043E

GENERAL

-  The KEOFIT CLASSIC "INGOLD" Sampling Valve owes its hygienic design and one-piece construction to the original KEOFIT valve. For 40 MM Ingold ports.
-  The product to be sampled should have a maximum viscosity of 0-1.000 cP and should not contain particles larger than 2 mm diameter.
-  The valve can be sterilized by means of SIP (EHEDG test) and cleaned by means of CIP (EHEDG certified). Suited for autoclave.
-  The sampling valve can be used for any process sampling for microbiological, chemical and/or physical analysis.



FEATURES

-  Installation: 40 mm Ingold port
-  Operation: Lever handle
-  Inlet / Outlet: Depending on choice of valve body
-  Membrane: EPDM (EPL-60 - black)

CERTIFICATION*

· Conforms to 3-A · EHEDG CIP · 3.1 Material Certificate · EU 1935/2004

TECHNICAL DATA

Material (product contact)

· Membrane EPDM (EPL-60 - black)

Material (without product contact)

· Steel parts AISI 303L (1.4305)
· Steel parts AISI 316L (1.4404)
· Lever handle AISI 316 (1.4404)

Membrane

· Article EPDM, BLACK (# 310052)
· Certification* FDA · USP · EU 1935/2004

Pressure & Temperature

· Pressure 0 - 6 bar (g) / 0 - 87 psi (g)
· Temperature 1 - 130° C / 34 - 266° F
· Air supply -



Net Weight

· Kg/lbs 0.375 kg / 0,83 lbs

Spareparts

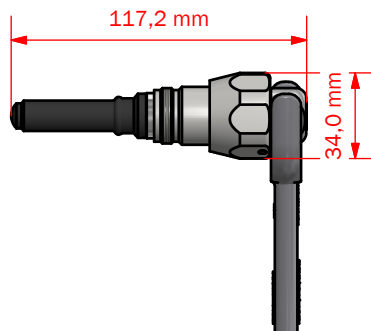
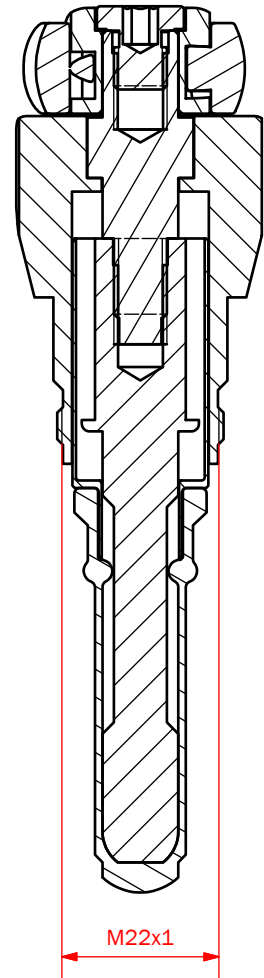
773141EPDM SPARE PARTS FOR I 40 MM HEAD 310041E/43E

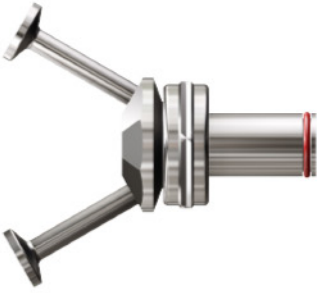
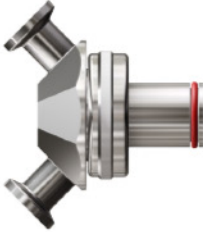
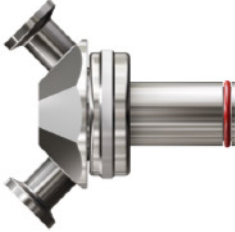

| Hose Piece | Standard for 40 mm port length | Standard for 52 mm port length |
|----------------|--|---|
| Mini Tri-Clamp | <p>Not available</p>  <p>310002</p> | <p>Not available</p>  <p>320002</p> |
| Welding liner | <p>On request</p>  <p>310005</p> | <p>On request</p>  <p>320005</p> |
| | | <p>On request</p>  <p>320007</p> |