





VALVE BODY TYPE I40, TC/TC

ART. NO. 310005

GENERAL

-  The KEOFITT CLASSIC "INGOLD" Sampling Valve owes its hygienic design and one-piece construction to the original KEOFITT valve. For 40 MM Ingold ports. Unique serial number engraved in each valve ("E" = internal electro polish).
-  Designed for sampling of liquids with a viscosity of up to approx. 1.000 cP containing no particles larger than Ø2 mm. Sampling of more viscous liquids is possible, only will it take longer (depending on process pressure).
-  Cleaning/sterilizing: Between batches: Valve in open position: Cleanable by means of CIP using the detergent solution suitable for the actual process media (EHEDG certificate available). Between samples: Valve in its normal closed position: cleanable by CIP as "Between batches" or the valve may be sterilized by means of steam SIP (EHEDG test report available) or chemical SIP using a procedure appropriate to the actual circumstances. For further advice, please contact Keofitt.
-  The sampling valve can be used for any process sampling for microbiological, chemical and/or physical analysis.

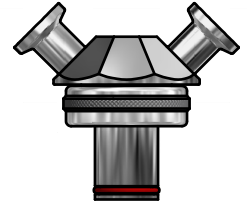

FEATURES

-  Installation: 40 mm Ingold port
-  Operation: Depending on choice of valve head
-  Inlet / Outlet: Mini Tri-Clamp
-  Membrane: Depending on choice of valve head

CERTIFICATION*

· EHEDG CIP · 3.1 Material Certificate · EU 1935/2004 · Ra Cert. incl. measurements

TECHNICAL DATA

Material (product contact)

- Steel parts AISI 316L (1.4435 BNII)
- O-ring Silicone (FDA · EU 1935/2004)

Material (without product contact)

- Steel parts AISI 316L (1.4435 BNII)

Surface Treatment

- Outside Electropolished Ra <= 1.2 µm
- Inside (wetted surface) Ra <= 0.2 µm
- Process connection Electropolished Ra <= 0.2 µm

Pressure & Temperature

- Pressure Depending on choice of valve head
- Temperature Depending on choice of valve head
- Air supply -

Net Weight

- Kg/lbs 0,478 kg / 1,05 lbs

Spareparts

- 300119 10 PACK O-RING 20,24 x 2,62 FDA

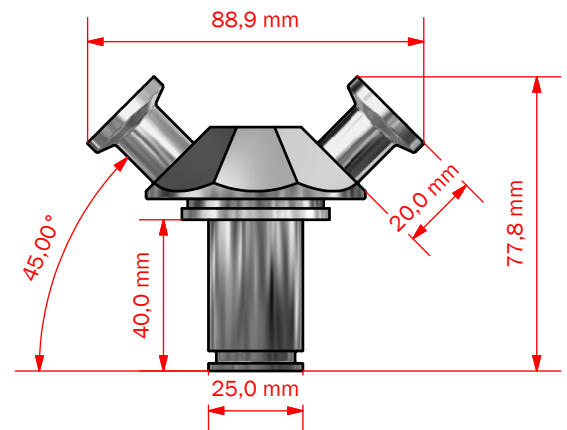
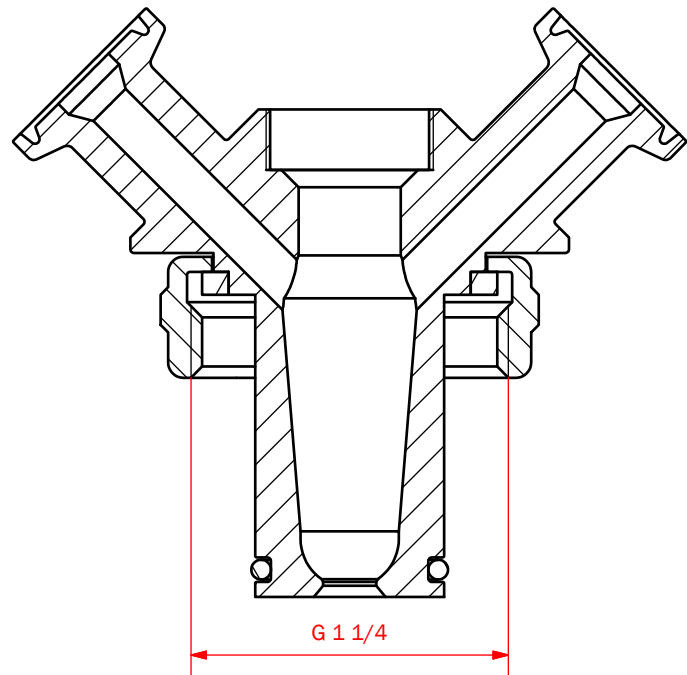
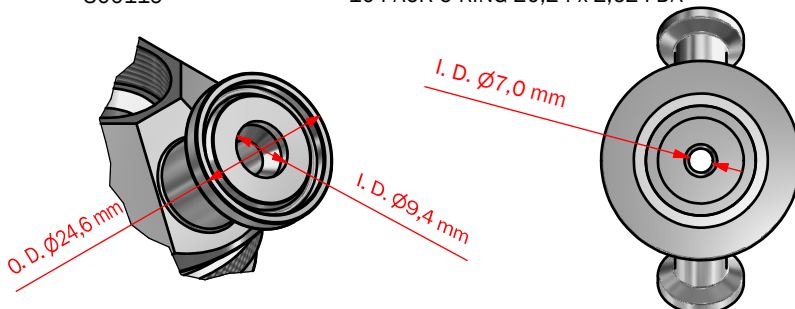

For 40 mm Ingold port			For 52 mm Ingold port					
Type H	Type Q	Type N	Type H	Type Q	Type N			
Turn knob 0-6 bar(g)	Lever handle 0-6 bar(g)	Lever handle Pneumatic 0-6 bar(g)	Turn knob 0-6 bar(g)	Lever handle 0-6 bar(g)	Lever handle Pneumatic 0-6 bar(g)			
 <p>310041</p>	 <p>310043</p>	 <p>310044</p>	 <p>320041</p>	 <p>320043</p>	 <p>320044</p>			
 <p>310041E</p>	 <p>310043E</p>	 <p>310044E</p>	 <p>320041E</p>	 <p>320043E</p>	 <p>320044E</p>			
 <p>315541</p>	 <p>315543</p>	 <p>315544</p>	 <p>325541</p>	 <p>325543</p>	 <p>325544</p>			
Silicone			EPDM			PTFE		