

VALVE BODY W9 TYPE P W/TC

ART. NO. 850010

GENERAL

The KEOFIT CLASSIC W9 Sampling Valve is the original and leading sterilizable sampling valve in the world. Used in all industries for decades. + 320 standard valve configurations. Unique serial no. for each valve ("E" = internal electro polish).

Valve body designed for sampling of liquids with a viscosity of up to approx. 1.000 cP containing no particles larger than Ø3 mm. Sampling of more viscous liquids is possible, only will it take longer (depending on process pressure).

Cleaning/sterilizing: Between batches: Valve in open position: Cleanable by means of CIP using the detergent solution suitable for the actual process media (EHEDG certificate available). Between samples: Valve in its normal closed position: cleanable by CIP as "Between batches" or the valve may be sterilized by means of steam SIP (EHEDG test report available) or chemical SIP using a procedure appropriate to the actual circumstances. For further advice, please contact Keofitt.

The sampling valve can be used for any process sampling for microbiological, chemical and/or physical analysis.

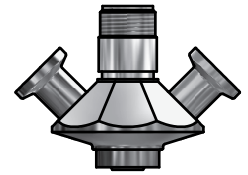

FEATURES

Installation: Pipe welding

Inlet / Outlet: Mini Tri-Clamp

Operation: Depending on choice of valve head

Membrane: Depending on choice of valve head

CERTIFICATION*

· EHEDG CIP · Conforms to 3-A · 3.1 Material Certificate · EU 1935/2004 · Ra Cert. incl. measurements

TECHNICAL DATA

Material (product contact)

· Steel parts AISI 316L (1.4435 BNII)

Material (without product contact)

· Steel parts AISI 316L (1.4435 BNII)
· Steel parts AISI 316L (1.4404)

Surface Treatment

· Outside Electropolished Ra <= 1.2 µm
· Inside (wetted surface) Electropolished Ra <= 0.5 µm
· Process connection Electropolished Ra <= 0.5 µm

Pressure & Temperature

· Pressure Depending on choice of valve head
· Temperature Depending on choice of valve head
· Air supply Depending on choice of valve head

Net Weight







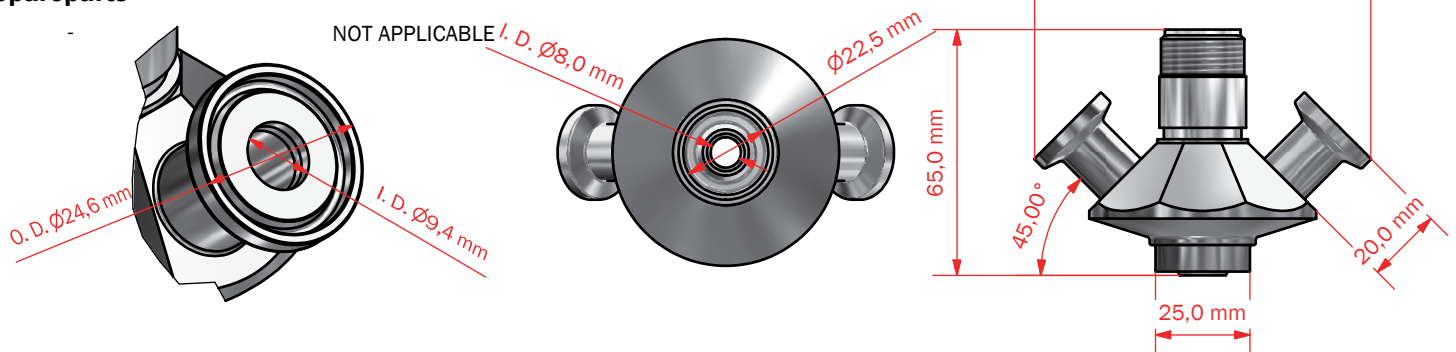
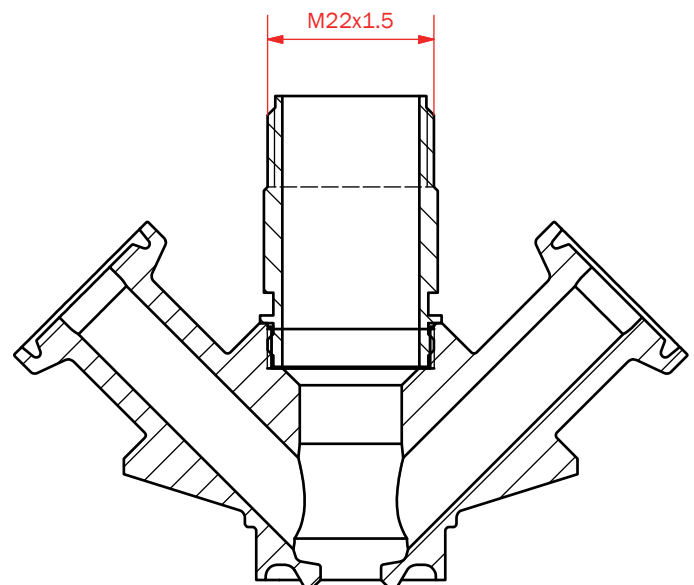





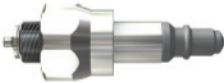



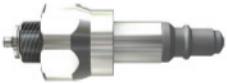
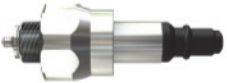

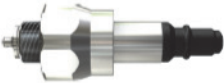
· Kg/lbs 0.386 kg / 0,85 lbs

Spareparts

· NOT APPLICABLE



W 9 HEADS

	Type H Turn knob		600041		600041E		855541
	Type H Turn knob with Microport option		600048		600048E	<i>Not available</i>	
	Type K Key ring		600042		600042E		855542
	Type K Key ring with Microport option		600049		600049E	<i>Not available</i>	
	Key Ring for valve head		600076		600076		600076
	Type Q Lever handle		600043		600043E		855543
	Type N Lever handle Pneumatic		600044		600044E		855544
	Type B No spring 0-1.2 bar(g)		600047		600047E		855547
Silicone							
EPDM							
PTFE							