

VALVE HEAD W9 TYPE N

ART. NO. 600044

GENERAL



The KEOFITT CLASSIC W9 Sampling Valve is the original and leading sterilizable sampling valve in the world market. Used across all industries from breweries to bio-pharm for decades. More than 320 standard valve configurations available.



The sampling valve can be used for any process sampling for microbiological, chemical and/or physical analysis.



The valve can be sterilized by means of SIP (EHEDG test) and cleaned by means of CIP (EHEDG certified). Not recommended for autoclave due to plastic parts.



The product to be sampled should have a maximum viscosity of 0-1.000 cP and should not contain particles larger than 3 mm diameter.

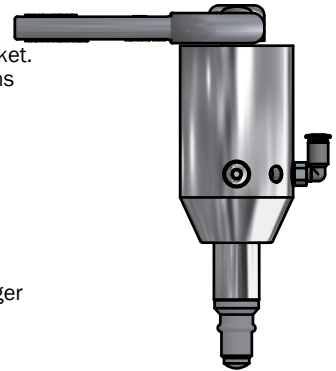

FEATURES



Installation: Threaded connection



Operation: Pneumatically operated/lever handle



Inlet / Outlet: Depending on choice of valve body



Membrane: Silicone (QBF-65 - grey)

CERTIFICATION*

· Conforms to 3-A · EHEDG CIP · EU 1935/2004

TECHNICAL DATA

Material (product contact)

· Membrane Silicone (QBF-65 - grey)

Material (without product contact)

· Steel parts AISI 303L (1.4305)
· Steel parts AISI 316L (1.4404)

Membrane

· Article SILICONE, GREY (# 600051)
· Certification* FDA · USP · EU 1935/2004

Pressure & Temperature

· Pressure 0 - 6 bar / 0 - 87 psi
· Temperature 1 - 130°C / 34 - 266° F
· Air supply 4 - 7 bar (g) / 58 - 101 psi (g)

Net Weight

· Kg/lbs 0.917 kg / 2,02 lbs

Spareparts

776044 PARTS FOR W9 HEADS 600044

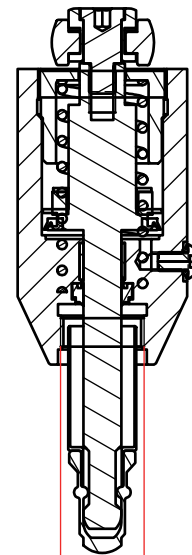



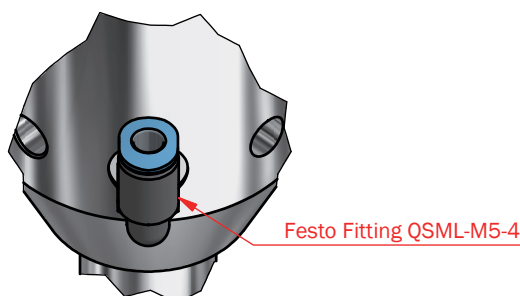



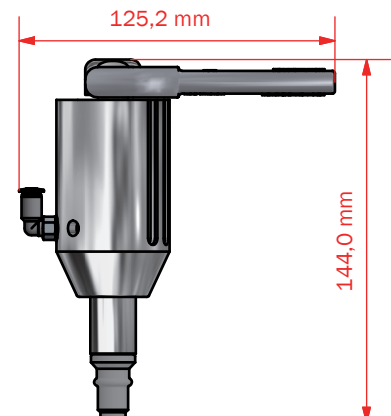













M22x1.5



Festo Fitting QSML-M5-4



W 9 HEADS

		Connection bodies						Welding bodies			
		Thread	Clamp 2"	Clamp 1"	Mini Clamp	Varivent Ø68	Varivent Ø50	Pipe Welding	Pipe Welding	Tank Welding	
											Hoses Piece
		850031	850003	850021	850036	850009	850008	850014	850011	850001	
		<i>On request</i>		 850022  850025			<i>On request</i>	<i>On request</i>			Mini Clamp
		<i>On request</i>	850005		850039	850013	<i>On request</i>	<i>On request</i>			
		<i>On request</i>	<i>On request</i>		<i>On request</i>	<i>On request</i>	<i>On request</i>				Thread M16x1,5
				850024				850018	850016	850015	